

Endurance PR Series Permanent-Magnet DC Motors

4-Inch, 5300 RPM, 1/2 HP Fixed Brush

Allied Motion's Endurance PR series of 4-inch (102mm) diameter PMDC motors are a cost-effective solution for a wide range of commercial applications such as handicap lifts, mobility vehicles, pumps, and gearmotors.

With rated voltages from 12 up to 48 VDC, and continuous power output up to 1/2 HP, the Endurance PR models are especially suited for battery-powered applications. They offer excellent performance, long service life, and high reliability. Custom design variations are available to exactly match application requirements.

Features & Benefits

- Gloss-black fully-dipped 4-inch (102mm) diameter steel tube field housing
- Rugged zinc die-cast end frames
- Continuous power output up to 1 HP (0.75kW)
- Continuous speed up 4800 RPM

- Sealed ball bearings
- IP54 protection level
- Optimized brush life
- Class B (130 °C) winding
- High strength ceramic magnets
- 1/2-inch (12.7 mm) cold-rolled steel shaft

Options

- Custom shaft and mounting configurations to match application requirements
- Stainless steel shaft
- Larger 0.669-inch (17 mm) shaft
- EMI/RFI suppression
- IP56 sealing (wash-down version)
- E-coated housing for corrosion protection
- Chrome or zinc plated housing
- High temperature Class H (180 °C) winding insulation
- Vented housing
- High strength steel thru bolts



- Reliable 4-inch diameter PMDC motor
- 12 to 48 VDC, up to 1/2 HP
- Heavy-duty, long life fixed brushes

SPECIFICATIONS

Model	Weight lb (kg)	Cont. Torque oz-in (Nm)	Cont. Speed RPM	No Load Speed RPM	Current			Cont. Power HP (W)
					Pk A	Cont. A	NL A	
PR46000Q	9.0 (4.08)	80 (0.56)	4800	5300	50	25	10	0.25 (187)
PR48000Q	12.0 (5.44)	160 (1.13)	2550	3000	60	30	10	0.33 (246)
PR4P000Q	15.0 (6.80)	192 (1.36)	1500	1900	60	40	10	0.40 (298)
PR4R000Q	18.0 (8.16)	240 (1.69)	1300	1700	60	40	10	0.50 (373)

Values above are nominal for a 12 volt DC motor. Contact Allied Motion for specific performance.

PMDC Motors

Endurance PR Series Permanent-Magnet DC Motors

DIMENSIONS

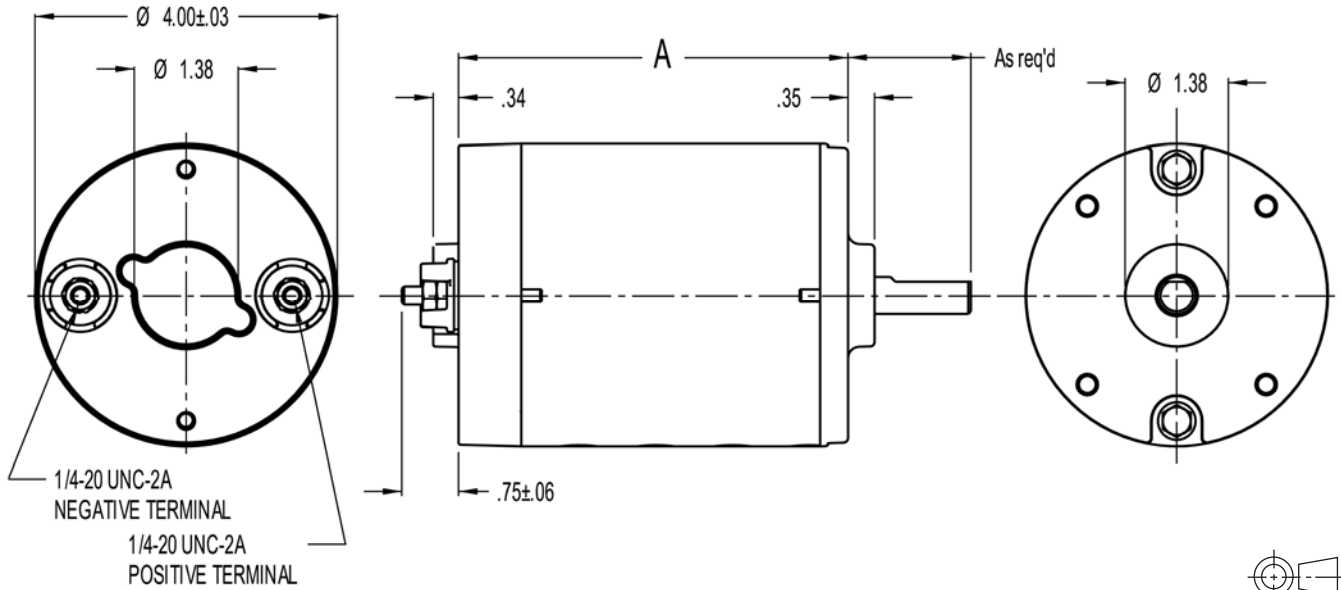

MODEL	PR46000Q	PR48000Q	PR4P000Q	PR4R000Q
Length A in (mm)	4.65 (118.2)	5.15 (130.9)	5.65 (143.6)	6.15 (156.3)

PERFORMANCE

PR46000Q

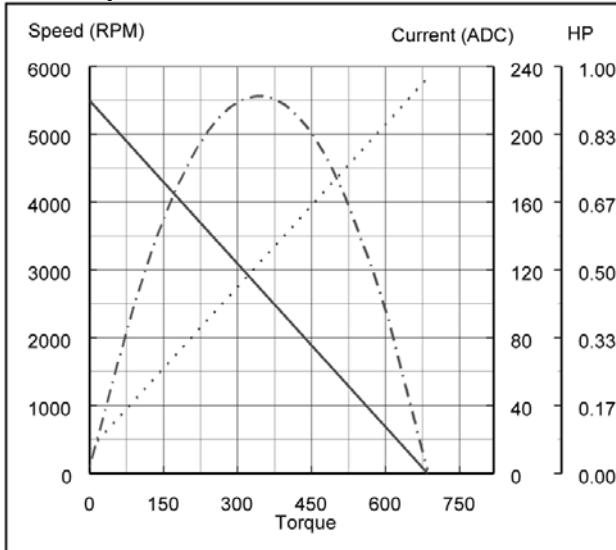

PR48000Q

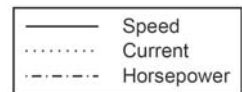
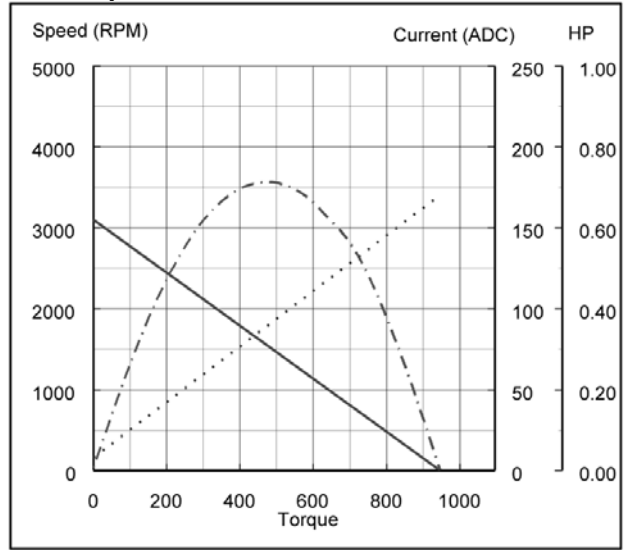

Endurance PR Series Permanent-Magnet DC Motors

PERFORMANCE

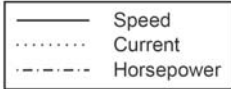
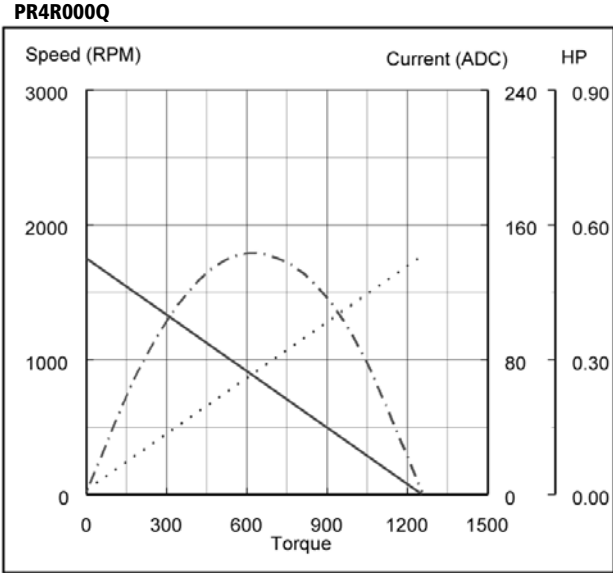
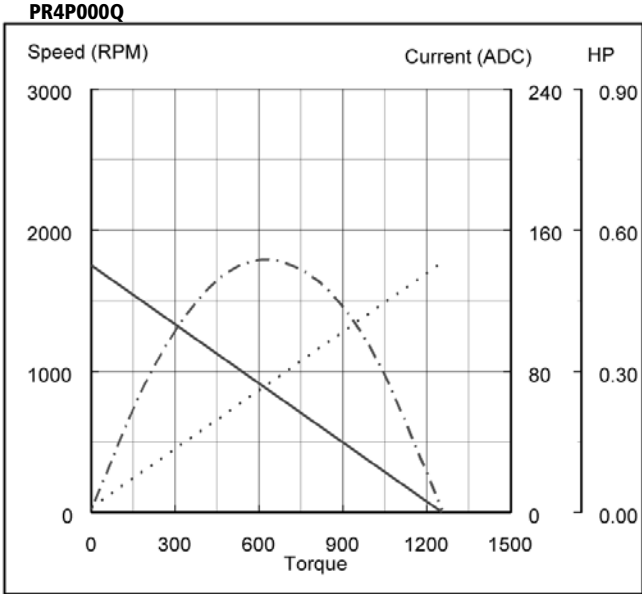

MODEL NUMBERING

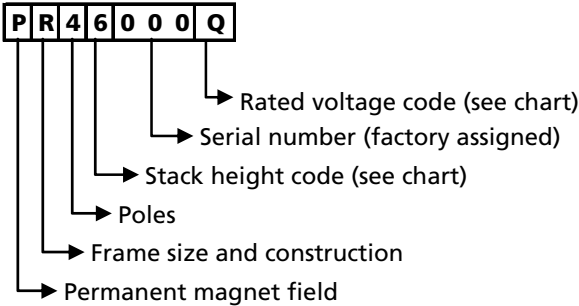

Stack Height (in.)
6 = 1.5
8 = 2.0
P = 2.5
R = 3.0

Voltage (VDC)
Q = 12
R = 24
Z = 36
G = 48



www.alliedmotion.com

