



Linear Actuators



Helping you build a better machine, faster.

Introduction

Company Introduction

The history of the Danaher Motion Electrak[®] actuator goes back to the development of ball screw actuators 40 years ago in Marengo, IL, USA. The first generation of general purpose actuators were developed for control of accessory drives on garden tractors and farm equipment. Since that simple beginning, actuators are now used in all types of equipment to automate a process, remove people from dangerous situations, provide remote control or make difficult, tedious manual jobs easier.

The linear actuators in this catalog represent proven design concepts found in the entire Electrak series. From light load 050s to the high performance Electrak Pro series capable of handling loads up to 2000 lbf, Danaher Motion offers features unavailable anywhere else.









The world's most versatile actuator selection

Danaher Motion combined the clevis to clevis mount Electrak series and the trunnion mount Electrak PPA units to provide the most versatile selection of linear actuators available. Our actuator team has solved over 10000 tough application challenges with even tougher actuators. We built our reputation in the mobile off highway market in extremely demanding operating conditions. And if you can't find the actuator to meet your application, call us for a cost effective actuator built to your needs. Danaher Motion builds more custom actuators than anyone.

You can count on Danaher Motion

Danaher Motion linear actuators—rugged, reliable remote linear motion control with the push of a button. You can count on Danaher Motion for worldwide sales, service, application support and local availability. Please visit www.danahermotion.com for more information.



1967	1969	1974	1982	1984	1987	1988	1991
The first generation of actuators for use in garden tractors and farm equipment is released.	First line of ball screw driven actuators with right angle AC and DC motors is released.	First line of actuators with parallel motors and both acme and ball screw drive is released.	The "Tiger" line actuators are released for OEMs.	Electrak 1, 2, 5, 10 and 100 are released for distribution.	Electrak 205 and the first line of MCS controls are released.	Electrak 1SP with feedback potentiometer is released.	The first lifting columns, DMD and DMA, are released.
							

Introduction

Product Introduction

Danaher Motion actuators are easy to mount and operate, require no maintenance, don't leak hydraulic fluid, are easy to incorporate into an automated process and once installed they will work reliably under the toughest conditions year after year.

Actuators offer advantages over mechanical and hydraulic systems in many applications. They are self-contained, rugged, and durable, making them ideal anywhere you want to lift, lower, push, pull, rotate or position a load.

Compact design

With their compact size, actuators can be located in confined areas. An actuator with a 4 inch stroke length can produce 2000 lbf of force from an 11 inch package. Electrak 1 and 050 series actuators fit small areas with package lengths as short as 6 inches.

Rugged and reliable

All Danaher Motion actuators incorporate strong, high quality components to assure trouble-free service. Rugged spur, worm or helical gearing, aircraft quality lubricants and high performance motors provide the maximum life and value. The actuators are gasketed and sealed throughout for protection in wet, dirty and oily environments and are ideal for use on outdoor equipment. The rod style actuators have stainless steel or aluminum extension tubes to resist corrosion.

Maintenance-free

All adjustments and lubrication are made at the factory and no maintenance is required or recommended. Consistent,

repeatable performance is provided for the entire lifetime of the actuator.

Bidirectional







Danaher Motion actuators can push and pull loads ranging from one pound to a ton, and can extend up to 36 inches. With the Danaher Motion series of actuator controls, you can create an actuator control system to meet your particular motion control requirements.

Safe operation

Motors used on Electrak actuators utilize thermal switches in their windings or Electronic Load Monitoring to shut the actuator off in case of overheating. A standard overload clutch or Electronic Load Monitoring will stop the motion if the load is too great or at the end of a stroke. All linear actuators will hold their loads with power removed.

Versatile

Stroke lengths of 1 to 36 inches are available and speeds are as high as 3 inches per second. Actuators are easy to apply, quick to install and usually only requiring two wires for operation. A wide variety of options and controls makes it easy to find the perfect actuator for your application. And if you have special needs, cost effective custom solutions are our specialty.

1992	1994	1998	1999	2000	2004	2006
A patent for a load lock device is granted.	Electrak 1LL is released.	Electrak 150 with two patents is released. AC control line is released.	Electrak 050 with patented design and the first rotary actuators are released.	The first LM80 rodless actuator is released.	The triple profile lifting column TC16 and the "sweeper" actuator are released.	The Electrak Pro actuator line and the DCG control line are released.
						

Introduction

The Benefits of Electrification

Electrification is converting manual, hydraulic and pneumatic operations to electromechanical motion. Substantially improved machine performance and cost advantages can be gained through electrification.

Reduce costs

- Electric actuation components cost less than comparable hydraulic and pneumatic systems.
- One electric linear actuator is faster and easier to install than the multiple hydraulic and pneumatic components required to achieve the same function.
- Electric actuators feature quick and predictable system tuning when compared to the headaches of configuring hydraulic systems and their components which contend with power variation, temperature variation, and non-linear performance profiles.
- Compare zero maintenance electric actuators against the fluid replacement, leak repairs and other routine maintenance needed to support hydraulic systems.
- Eliminate the environmental problems and costs associated with hydraulic fluid leaks and fluid disposal.

Boost productivity and efficiency

- Improve control over critical machine operations with:
 - Multiple digital and analog feedback options
 - Fixed and programmable limit switches for “teach and repeat” positions
 - Low voltage switching options that can interface directly with programmable PC/PLC controllers
 - Pulse width modulation for variable speed control
- Superior accuracy and repeatability
- Link and automate simultaneous processes
- Reduce down time with:
 - Zero maintenance
 - Longer component life
 - Redundancy through manual override
- Improve safety and reduce costs by removing people from danger with convenient remote control

Great opportunities for electric conversion

Making jobs easier

- Raising and lowering a deck on a mower, paver or floor scrubber.
- Shifting manual transmission.
- Lifting wheelchairs into a vehicle.
- Opening and closing doors on buses or vans.

Automating a process

- Moving twine across a round bale of hay for consistent wrap.
- Varying the chute opening on a salt/sand spreader based on speed for consistent application.
- Lift and lower pantographs on electrical trains and trams.

Providing remote control

- Throttle control from the rear of garbage trucks.
- Positioning the discharge spout on a large chipper, snowblower or combine.
- Opening a chute on a salt/sand spreader.
- Positioning of solar energy panels and wind power plant turbines.
- Opening/closing the engine hatch on boats.
- Positioning boat, handicap vehicle seats.
- Belt tensioning.

Removing people from danger

- Sliding a cover over the stairs in a recreational vehicle.
- Throttle control for a tree stump grinder to keep the operator away from moving parts or flying debris.
- Medical waste/refuse compacting.

Replacing hydraulics or pneumatics

- Power steering.
- Dump beds on ATVs.
- Positioning mower decks on golf course equipment.



Introduction

The Benefits of Electrification

Replacing hydraulic or pneumatic cylinders with electrical linear actuators means a simpler and smaller installation, easier control, lower energy costs, higher accuracy, less maintenance, less noise and a cleaner, healthier environment.

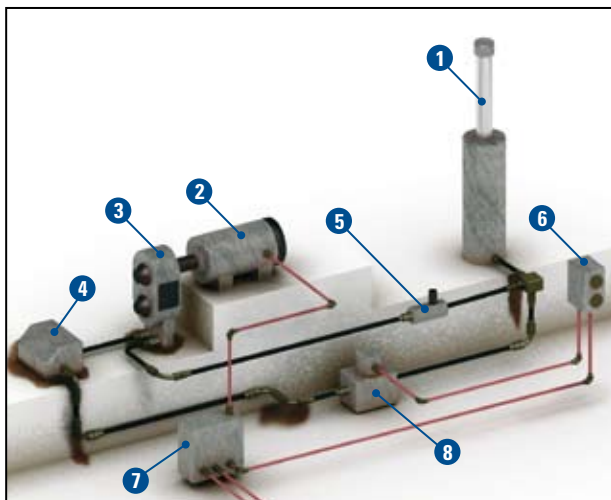

You can design, purchase and install all these components or you can select and install an actuator and control.

Single acting, uni-directional hydraulic cylinder system

1. Hydraulic cylinder
2. Electric pump motor
3. Hydraulic pump
4. Hydraulic oil reservoir
5. Check valve
6. Operator push button box
7. Relay cabinet
8. Unloading valve

This single acting, uni-directional hydraulic cylinder system is one of the simplest hydraulic solutions. This system only allows consistent performance in one direction. In order to get consistent performance in both directions a bi-directional system would be required which is even more complex and costly.

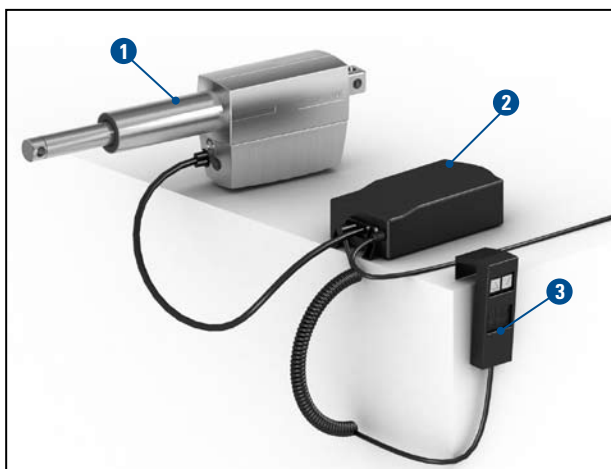

Plug and play type of connections, simple installation and no need for any set up or adjustments ensures accurate, clean and trouble free operation within the hour.

Electric linear actuator system

1. Linear actuator
2. Actuator control
3. Hand held control pendant

This simple electrical actuators system will ensure consistent operation in both directions. It will also give you added features such as electronic load monitoring, end of stroke limit switches, mid stroke protection and manual override operation in case of power failure. Optional features such as analog or digital position feedback, adjustable end of stroke limit switches, end of stroke indication outputs and signal following capability are also available. Another advantage is that a system like this is easy to integrate with other control systems normally found in industrial systems or vehicles such as PLC's, micro-controllers, computers or simple relay based systems.

Introduction

Actuator Applications

Danaher Motion Electrak actuators can be found in the most diverse applications, ranging from agricultural to industrial, ventilation and medical equipment. Anywhere you want to lift, lower, push, pull, rotate or position a load - only your imagination will set the limit.

Mobile-off-highway

Actuators are widely used in agricultural, construction, mining, forestry, marine, road work and railway equipment for positioning seats, hoods, covers, doors, throttles, sprayer or auger booms, pantographs, chutes, gates, hydraulic valves, shifting transmissions and much more.

Turf and garden

Actuators can be found on riding lawn mowers, golf carts, garden tractors, cleaning machines, sky lifts and other utility vehicles for throttle control, dump bed, deck lift, transmission shift and positioning brushes and squeegees.

Energy alternatives

Actuators are used to position solar panels during the day and to return them to a rest position at night. They are also used on wind mills to open and close ventilation ducts and access panels.

Industrial, ventilation and process control equipment

Actuators are used on conveyor belts, adjustable work tables and in the opening and closing of hatches, doors and locks. They are also common in machines for dispensing, cutting, packaging, labeling, scanning or printing as well as for valve control in ventilation and process equipment.

Health and fitness

Actuators are commonly used in wheel chairs, patient lifts/beds, hospital devices, handicap adapted vehicles, examination chairs/tables and work out/gym apparatus to position users, patients or equipment.

Office, domestic and entertainment equipment

Actuators are used in automatic doors, lifts, garage doors, gates, satellite dishes, beds, reclining chairs, adjustable office desks, arcade games, vending machines, theatre/TV/movie props and theme park attractions.



Introduction

Actuator Product Groups

Danaher Motion actuators have been divided into good, better, best and custom groups to help you select the appropriate actuator. The following pages will describe the actuators in each group, their features and benefits, typical applications and what sets them apart from the others.

Good

These actuators are the lowest cost solution, provide capable, reliable performance and have some flexibility of options and configurations. If you just need a basic actuator, this is the best choice.

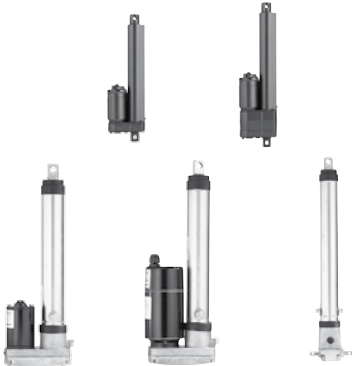

Best

These robust and strong actuators are the market leaders with state of the art technology and flexibility. They are smaller, lighter and have a shorter retracted length than other actuators on the market. If you need electronic load monitoring, programmable limit switches, digital feedback or signal following, this is the group for you.



Better

These actuators have more flexibility in options, configurations and modifications. They have passed the test of time in the toughest agriculture and construction applications. Choose from this group if you need a rugged, heavy duty actuator customized to your application.

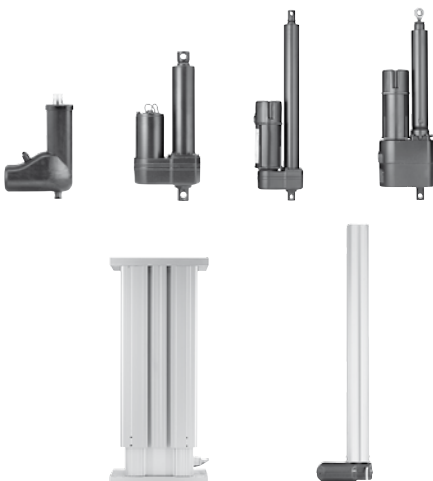

Custom

The actuators found in the good, better and best groups are some of the building blocks we use to create cost effective custom actuators. Don't hesitate to contact us for a custom solution, Danaher Motion is the industry leader in custom actuator design.

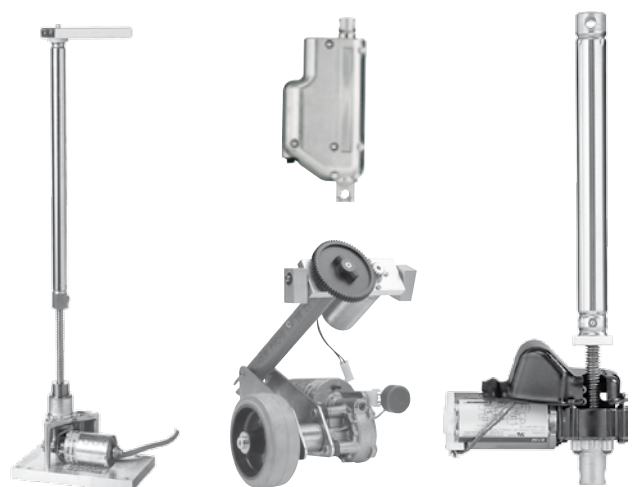

Good Group

Basic, Reliable, Low Cost Actuators

These actuators are the lowest cost solution, provide capable, reliable performance and have some flexibility of options and configurations. If you just need a basic actuator, this is the best choice.

Electrak 1

Electrak 1 actuators are compact with stroke lengths up to 6 inches, loads up to 75 lbf and have either end of stroke limit switches or potentiometer feedback. They are weatherproof, only require two wire control and have clevis to clevis mounting. These are our smallest actuators and are available in either 12 or 24 Vdc models.

- Corrosion free housing with IP65 rating.
- Built in end of stroke limit switches or feedback potentiometer.
- Self locking acme screw drive.
- Motor with auto reset thermal switch.



Electrak PPA

The Electrak PPA are good basic actuators. They have trunnion mounting in the rear with clevis on the extension tube, loads to 1500 lbf, strokes to 36 inches, and are available in 12, 24, 36 and 90 Vdc or 115 and 230 Vac. A built in overload clutch is included as standard and options include end of stroke limit switches, encoder or potentiometer feedback and a manual over ride.

- Overload clutch for mid and end of stroke protection.
- Efficient ball screw drive.
- Versatile actuator with high duty cycle.
- Motor with auto reset thermal switch.



Better Group

Flexible, Rugged, Heavy Duty Actuators

These actuators have more flexibility in options, configurations and modifications. They have passed the test of time in the toughest agriculture and construction applications. Choose from this group if you need a rugged, heavy duty actuator customized to your application.

Electrak 050

For loads up to 112 lbf, select the very compact Electrak 050 actuator. It has stroke lengths to 8 inches with end of stroke limit switches and an overload clutch as standard. It is maintenance free, corrosion free and available in 12, 24 or 36 Vdc versions.



- Corrosion free plastic housing.
- Very short retracted length.
- Internally restrained extension tube.
- Motor with auto reset thermal switch.

Electrak 2, 5, 10 and 205

The Electrak 2,5,10 and 205 actuators are rugged, proven actuators available in a variety of voltages, strokes and mounting configurations. Loads to 1500 lbf, available with options such as limit switches, potentiometer feedback or overload clutch.

- Very robust, strong and reliable actuators.
- Motor with auto reset thermal switch.
- Acme or ball screw drive.
- AC or DC supply voltage.



DMD and DMA lifting columns

The self supporting DMD and DMA lifting columns are available in 12, 24, and 36 Vdc or 115 and 230 Vac, can lift up to 1500 lbf with strokes to 24 inches. The maximum torque rating is 6300 lbf-in. Potentiometer feedback is optional.

- Designed for industrial use.
- Acme or ball screw drive.
- High load torque capability.
- Overload clutch.
- Motor with auto reset thermal switch.



LM80 rodless actuators

The LM80 rodless actuators are available for either horizontal or vertical applications, 12 or 24 Vdc, strokes to 1500 mm (59 inches) and loads to 450 lbf. These fast actuators have a carriage that can travel at speeds up to 4.44 inches/sec along the self supporting aluminum profile.

- For use in domestic, office or medical applications.
- Lightweight and quiet operation.
- Easy and fast T-slot mounting.
- Durable and corrosion free.
- Acme or ball screw drive.



Best Group

Robust, Strong, State of the Art Actuators

The Electrak Pro series is the next generation of linear actuators from Danaher Motion packed with new and unique features. Electronic Load Monitoring, dynamic braking and IP66 protection are some of the standard features. Add the broad range of options to the mix and the Pro series gives you more versatility than any other actuator.

The Electrak Pro series is not designed for the ordinary tasks. Instead the Pro series stands alone when it comes to the toughest and most demanding applications. When space is scarce, where dust, dirt and water is abundant and when solid, reliable and maintenance free operation is a must - Electrak Pro is the answer.

What is special for most is standard for a pro

The Electrak Pro series is packed with standard features developed for applications where performance is essential. Electronic load monitoring (ELM), electronic limit switches (ELS), dynamic braking, manual override and IP66 protection are all standard features.

Electronic load monitoring

A built-in micro processor continuously monitors the performance of the actuator. The processor will stop the movement at the end of stroke and also in case of mid stroke stall, at overload conditions or if the duty cycle is too high. It also eliminates the need of a clutch and provides dynamic braking.

Broad range of unique options

The Electrak Pro series offers a broad range of options including programmable limit switches, low voltage power switching, PWM speed control monitoring, signal follower control, analog or digital position feedback and end of stroke indication outputs, with most being available in the standard compact envelope.

- Optimized overall envelope with minimal retracted length.
- Durable and corrosion resistant aluminum housing.
- Cover tube and extension tube in stainless steel.
- Designed for heavy duty operation.
- Acme or ball screw models.
- Wide range of options.



Best Group

Robust, Strong, State of the Art Actuators

The TC16 lifting column is another product innovation from Danaher Motion. The TC16 is designed to be used in domestic, medical and office environments, as well as in disability equipment and has all the hallmarks you expect from a Danaher Motion actuator; quality, easy installation and long, trouble free life.

Designed to suit many applications, the TC16 will fit perfectly into all kinds of medical, disability, rehabilitation or health and fitness equipment. With a very low retracted versus stroke length ratio, a TC16 is the ideal product for applications that demand a high load in a space critical environment.

Innovative design

The innovative and aesthetic design of the extruded aluminum profiles allows the TC16 to be a visible component. This eliminates the need for cover plates or enclosures, reduces material cost, assembly time and makes servicing easy.

State of the art technologies

The TC16 is built around double-telescoping lead screws and a gearbelt driven by a high quality DC motor. This unique design ensures quiet operation in a highly efficient package, providing high load capacity with minimum current draw. The guiding technology used between the aluminum profiles uses the latest anti-friction material creating a high moment load capability in a very small envelope. Smooth, quiet, rigid and maintenance free operation are other benefits of the guiding technology used in the TC16.

- Designed for domestic, office and medical applications.
- Low weight and quiet operation.
- Smooth operating telescopic screw drive.
- High load torque capability.
- Very short retracted length.
- Very low stroke to retracted length ratio.

Features that makes the difference

The TC16 is packed with features. It has built-in end of stroke limit switches and utilizes dynamic braking for short and consistent stops. With power off, the integrated load holding brake will keep the unit securely in position. The TC16 are also EMC approved according to medical standards, has a surface treatment according to furniture standards and an IP44 rating. It's also available with encoder feedback, making it easy to synchronize the motion of two or more units.



Custom Group

Custom Actuators - Our Speciality

Danaher Motion has been building actuators for 40 years and creating custom actuators from the very beginning - our first actuator was a custom design. Today we build more custom actuators than anyone and we are the industry leader in custom actuator design.

Danaher Motion builds cost effective custom actuators for the most demanding applications - heat, cold, vibration, shock, wet, dirty, oily - using the standard actuators you can see in this catalog as the building blocks. We also build actuators with very different characteristics as you can see from some of the examples below.

the relevant data and the correct ordering information for all of our standard actuators. If you still can't find a suitable actuator, then contact one of our field sales engineers or one of our application engineers. And if they can't find a standard actuator that meets your requirements, we can design an actuator specific to your needs.

How to get the perfect actuator for your application

First review the performance of our actuators in the catalog and see if there is any actuators that meet the needs of your application. Next, go to our online selection tool on www.danahermotion.com/linear_actuator_advisor to review your actuator selection. This easy to use software lets you fine-tune all the parameters and will give you all



Actuator Controls

Controls For All Purposes

Danaher Motion has a full line of actuator controls ranging from simple switches to synchronizing controls that can synchronize the motion of two lifting columns or two actuators at once.

The simplest and most basic control is the on-off-on (DPDT) switch for panel mounting and extending or retracting an actuator with a center "off" position.

The MCS series

The MCS series of controls provides voltage conversion to allow DC actuators to be operated with AC input voltage. These controls range from a simple power supply for use with remote switches to a control with membrane switches and per cent of stroke meters on the cover. There are also versions with AC input, AC output, and a built in capacitor for controlling AC actuators.

The new DCG line

The new DCG controls provides power conversion from AC to DC along with hand held pendant controls for convenient operation of the actuator. These small and lightweight controls have built in Electronic Limit Switches

(ELS) to stop the actuator at end of stroke or if there is a stall or overload mid stroke. There is also a version that will operate two lifting columns equipped with encoders synchronously.

The Pro series

The Pro series of actuators can have a variety of control options built right into the actuator - signal following, programmable end of stroke limit switches, low level switching capability, and overload or end of stroke trip indication. Electronic Load Monitoring (ELM) is included as standard on all Pro series.







Special controls

If you need some special control included in the actuator, contact one of our application engineers or salesmen. We build more custom actuators than anyone.



Performance Overview

Driven Linear Actuators

	ELECTRAK					
	1	1SP	050	2	PPA-DC	10
						
Product availability						
North America / Europe / Asia ¹	•/•/•	•/•/•	•/•/•	•/ /	•/•/•	•/•/•
General performance						
Product group rating	good	good	better	better	good	better
Input voltage [Vdc / Vac]	12, 24, 36 ² /	12, 24, 36 ² /	12, 24, 36 /	12 /	12, 24, 36, 90 ³ /	12, 24, 36 /
Maximum dynamic load [lbf]	75	75	112	250	1500	1500
Maximum speed [in/sec]	3.0	3.0	1.9	1.2	1.3	2.4
Maximum stroke length [in]	6	6	8	24	36	24
Restraining torque [lbf-in]	20	0	0	65	200	100
Protection class	IP65	IP65	IP56	IP65	IP52	IP65
Features						
Mounting configuration	clevis	clevis	clevis	clevis	trunnion	clevis
Screw type - acme / worm / ball	• / /	• / /	/•/	• / /	/ /•	• ² / /•
Overload clutch			•	•	•	•
Motor overload protection	•	•	•	•	•	•
End of stroke limit switches	•		•			
Potentiometer feedback		•				
Electronic load monitoring						
Dynamic braking			• ⁷			
Manual override						
Optional features						
End of stroke limit switches				• ³	•	• ³
Potentiometer feedback			•	•	•	•
Encoder feedback					•	
Programmable limit switches						
End of stroke indication outputs						
Low voltage power switching						
Signal follower input						
PWM speed control monitoring						
Manual override				•	• ³	•

¹ Contact customer support for more information on regional differences. ² Not available in North America. ³ Not available in Europe.

USA, Canada and Mexico

Danaher Motion
203A West Rock Road
Radford, VA 24141 USA
Phone: 1-540-633-3400
Fax: 1-540-639-4162
E-mail: DMAC@danahermotion.com

United Kingdom

Danaher Motion
Chartmoor Road, Chartwell Business Park
Leighton Buzzard, Bedfordshire
LU7 4WG; United Kingdom
Phone: +44 (0)1525 243 243
Fax: +44 (0)1525 243 244
E-mail: sales.uk@danahermotion.com

Germany

Danaher Motion GmbH
Sales Office North
Wacholderstr. 40-42
40489 Düsseldorf
Germany
Phone: +49 (0) 203 9979 214
Fax: +49 (0) 203 9979 3214
E-Mail: iris.tolusch@danahermotion.com

Danaher Motion GmbH
Sales Office South West
Brückenfeldstraße 26/1
75015 Bretten
Germany
Phone: +49 (0) 7252 96462 10
Fax: +49 (0) 7252 96462 69
E-Mail: kerstin.mueller@danahermotion.com

Danaher Motion GmbH
Sales Office South East
Kiesgräble 7
89129 Langenau
Germany
Phone: +49 (0) 7471 62 23 23
Fax: +49 (0) 7471 62 23 26
E-Mail: ursula.koschak@danahermotion.com

France

Danaher Motion
C.P 80018
12, Rue Antoine Becquerel – Z.I. Sud
72026 Le Mans Cedex 2
France
Phone: +33 (0) 243 50 03 30
Fax: +33 (0) 243 50 03 39
E-mail: sales.france@danahermotion.com

Italy

Danaher Motion srl
Largo Brughetti
20030 Bovisio Masciago
Italy
Phone: +39 0362 594260
Fax: +39 0362 594263
E-mail: info@danahermotion.it

Sweden

Danaher Motion
Box 9053
291 09 Kristianstad
Sweden
Phone: +46 (0) 44-24 67 00
Fax: +46 (0) 44-24 40 85
E-mail: sales.scandinavia@danahermotion.com

Switzerland

Danaher Motion SA
La Pierreire 2
1029 Villars-Ste-Croix
Switzerland
Phone: +41 (0) 21 631 33 33
Fax: +41 (0) 21 636 05 09
E-mail: info@danaher-motion.ch

China

Danaher Motion
Rm 2205, Scitech Tower
22 Jianguomen Wai Street
Beijing, China, 100004
Phone: +86 10 6515 0260
Fax: +86 10 6515 0263
E-mail: chinainfo@danahermotion.com.cn

Japan

Danaher Motion Japan
2F, Tokyu Reit Hatchobori Bldg,
2-7-1 Hatchobori Chuo-ku,
Tokyo 104-0032 Japan
Phone: +81-3-6222-1051
Fax: +81-3-6222-1055
E-mail: info@danahermotion.co.jp

Asia Pacific

Danaher Motion (HK) Ltd
Unit A, 16 Floor, 169 Electric Road
Manulife Tower, North Point
Hong Kong
Phone: +852 2503 6581
Fax: +852 2571 8585
E-mail: victor.lim@danahermotion.com

TPS T.J11/07 200707-04 USA
Information & specifications subject to change at any time. Printed in USA.
© Danaher Motion 2007