

TSM17C

Integrated Step-Servo Motor



Hardware Manual
Rev. A



Contents

1	Introduction	3
1.1	Features	3
1.2	Block Diagram	4
1.3	Safety Instructions	5
2	Getting Started	6
2.1	Installing Software	6
2.2	Mounting the Hardware	6
2.3	Choosing a Power Supply	7
2.3.1	Voltage	7
2.3.2	Regeneration Clamp	7
2.3.3	Current	8
3	Installation/Connections	12
3.1	Connecting the Power Supply	12
3.2	Connecting the TSM17C Communications.....	13
3.2.1	Node ID	14
3.2.2	Setting the Baudrate.....	14
3.3	Inputs and Outputs	15
3.3.1	Connector Pin Diagram	15
3.3.2	X1 & X2 Digital Input	16
3.3.3	X3/X4/X5/X6 Digital Input.....	17
3.3.4	X7/X8 Digital Input.....	18
3.3.5	Programmable Output Y1/Y2/Y3.....	19
3.3.6	Programmable Output Y4.....	20
4	Troubleshooting	21
5	Reference Materials	22
5.1	Torque-Speed Curves.....	22
5.2	Mechanical Outlines	23
5.3	Technical Specifications.....	24
6	Contacting Applied Motion Products.....	25

Model	Communications	
	RS-232	CANopen
TSM17C-1CG	✓	✓
TSM17C-2CG	✓	✓
TSM17C-3CG	✓	✓

1 Introduction

Thank you for selecting the Applied Motion Products TSM17C Integrated Motor. The TSM line of integrated step-servo motors combines servo technology with an integrated motor to create a product with exceptional features and broad capabilities. We hope our commitment to performance, quality and economy will result in a successful motion control project.



1.1 Features

- Programmable, Digital servo driver and motor in an integrated package
- Operates from a 12 to 48 volt DC power supply
- Control Modes:
 - CANopen (compliant CiA 402)
 - * Profile Torque
 - * Profile Velocity
 - * Profile Position
 - * Homing
 - Q Programming
 - * Execute stored Q programs via Applied Motion Products specific CANopen objects
- Communications:
 - CANopen & RS-232
- 5000 line (20,000 counts/rev) encoder feedback
- Available torque:
 - TSM17C-1CG: Up to 0.28 N•m Continuous (0.35 N•m Boost)
 - TSM17C-2CG: Up to 0.42 N•m Continuous (0.52 N•m Boost)
 - TSM17C-3CG: Up to 0.52 N•m Continuous (0.68 N•m Boost)
- I/O:
 - 8 optically isolated digital inputs, with adjustable bandwidth digital noise rejection filter, 5 to 24 volts
 - 4 optically isolated digital output, 30V/100 mA max.
 - 1 analog input, 0 to 5 volts
- Technological advances:
 - Full servo control, Closed loop
 - Efficient, Accurate, Fast, Smooth
 - Intelligent, Compact

1.2 Block Diagram

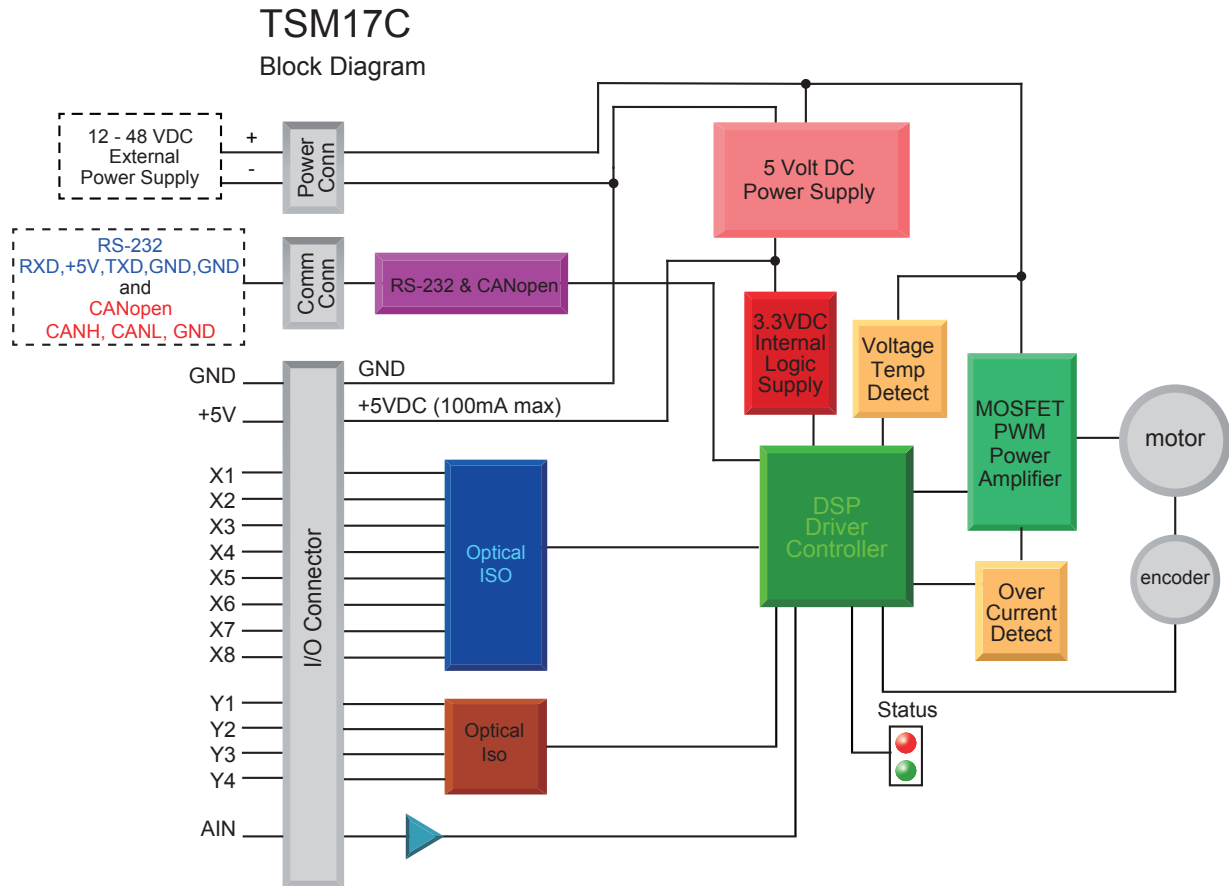

1.3 Safety Instructions

Only qualified personnel should transport, assemble, install, operate, or maintain this equipment. Properly qualified personnel are persons who are familiar with the transport, assembly, installation, operation, and maintenance of motors, and who meet the appropriate qualifications for their jobs.

To minimize the risk of potential safety problems, all applicable local and national codes regulating the installation and operation of equipment should be followed. These codes may vary from area to area and it is the responsibility of the operating personnel to determine which codes should be followed, and to verify that the equipment, installation, and operation are in compliance with the latest revision of these codes.

Equipment damage or serious injury to personnel can result from the failure to follow all applicable codes and standards. Applied Motion Products does not guarantee the products described in this publication are suitable for a particular application, nor do they assume any responsibility for product design, installation, or operation.

- Read all available documentation before assembly and operation. Incorrect handling of the products referenced in this manual can result in injury and damage to persons and machinery. All technical information concerning the installation requirements must be strictly adhered to.
- It is vital to ensure that all system components are connected to earth ground. Electrical safety is impossible without a low-resistance earth connection.
- This product contains electrostatically sensitive components that can be damaged by incorrect handling. Follow qualified anti-static procedures before touching the product.
- During operation keep all covers and cabinet doors shut to avoid any hazards that could possibly cause severe damage to the product or personal health.
- During operation, the product may have components that are live or have hot surfaces.
- Never plug in or unplug the Integrated Motor while the system is live. The possibility of electric arcing can cause damage.

Be alert to the potential for personal injury. Follow recommended precautions and safe operating practices emphasized with alert symbols. Safety notices in this manual provide important information. Read and be familiar with these instructions before attempting installation, operation, or maintenance. The purpose of this section is to alert users to the possible safety hazards associated with this equipment and the precautions necessary to reduce the risk of personal injury and damage to equipment. Failure to observe these precautions could result in serious bodily injury, damage to the equipment, or operational difficulty.

2 Getting Started

The following items are needed:

- a 12 - 48 Volt DC power supply, see the section below entitled “Choosing a Power Supply” for help in choosing the right one
- a small flat blade screwdriver for tightening the connectors (included)
- a PC running Microsoft Windows XP, Vista, or Windows 7 or 8
- an Applied Motion Products programming cable for RS-232 interface and another cable for CANopen daisy-chain(both included with TSM17C)

2.1 Installing Software

Before utilizing the TSM17C Integrated Step-Servo Motor and Step-Servo Quick Tuner Software in an application, the following steps are necessary:

- Install the Step-Servo Quick Tuner software from the Applied Motion Products website.
- Connect the drive to the PC using the programming cable.
- Connect the drive to the power supply. See instructions below.
- Launch the software by clicking Start...Programs...Applied Motion Products.
- Apply power to the drive.
- The software will recognize the drive and display the model and firmware version. At this point, it is ready for use.

2.2 Mounting the Hardware

As with any step motor, the TSM17C must be mounted so as to provide maximum heat sinking and airflow. Keep enough space around the Integrated Motor to allow for airflow.



- Never use the drive where there is no airflow or where other devices cause the surrounding air to be more than 40°C (104°F).
- Never put the drive where it can get wet.
- Never use the drive where metal or other electrically conductive particles can infiltrate the drive.
- Always provide airflow around the drive.

2.3 Choosing a Power Supply

The main considerations when choosing a power supply are the voltage and current requirements for the application.

2.3.1 Voltage

The TSM17C is designed to give optimum performance between 24 and 48 Volts DC. Choosing the voltage depends on the performance needed and motor/drive heating that is acceptable and/or does not cause a drive over-temperature. Higher voltages will give higher speed performance but will cause the TSM17C to produce higher temperatures. Using power supplies with voltage outputs that are near the drive maximum may significantly reduce the operational duty-cycle.

The extended range of operation can be as low as 10 VDC minimum to as high as 55 VDC maximum. When operating below 18 VDC, the power supply input may require larger capacitance to prevent under-voltage and internal-supply alarms. Current spikes may make supply readings erratic. The supply input cannot go below 10 VDC for reliable operation. Absolute minimum power supply input is 10 VDC. If the Input supply drops below 10 VDC the low voltage alarm will be triggered. This will not fault the drive.

Absolute maximum power supply input is 55 VDC at which point an over-voltage alarm and fault will occur. When using a power supply that is regulated and is near the drive maximum voltage of 55 VDC, a voltage clamp may be required to prevent over-voltage when regeneration occurs. When using an unregulated power supply, make sure the no-load voltage of the supply does not exceed the drive's maximum input voltage of 55 VDC.

2.3.2 Regeneration Clamp

If a regulated power supply is being used, there may be a problem with regeneration. When a load decelerates rapidly from a high speed, some of the kinetic energy of the load is transferred back to the power supply, possibly tripping the over-voltage protection of a regulated power supply, causing it to shut down. This problem can be solved with the use of an Applied Motion Products RC880 Regeneration Clamp. It is recommended that an RC880 initially be installed in an application. If the "regen" LED on the RC880 never flashes, the clamp is not necessary.

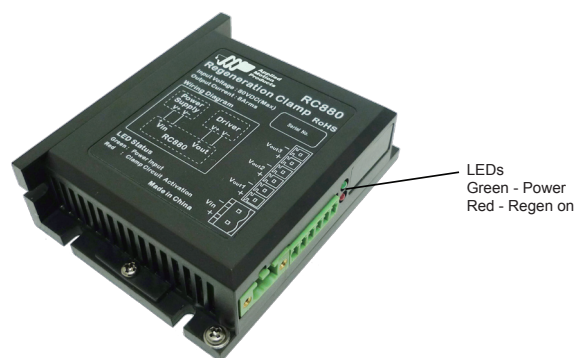

RC880 Regen Clamp

2.3.3 Current

The maximum supply currents required by the TSM17C are shown in the charts below at different power supply voltage inputs. The TSM17C power supply current is lower than the winding currents because it uses switching amplifiers to convert a high voltage and low current into lower voltage and higher current. The more the power supply voltage exceeds the motor voltage, the less current will be required from the power supply.

It is important to note that the current draw is significantly different at higher speeds depending on the torque load to the motor. Estimating how much current is necessary may require a good analysis of the load the motor will encounter.

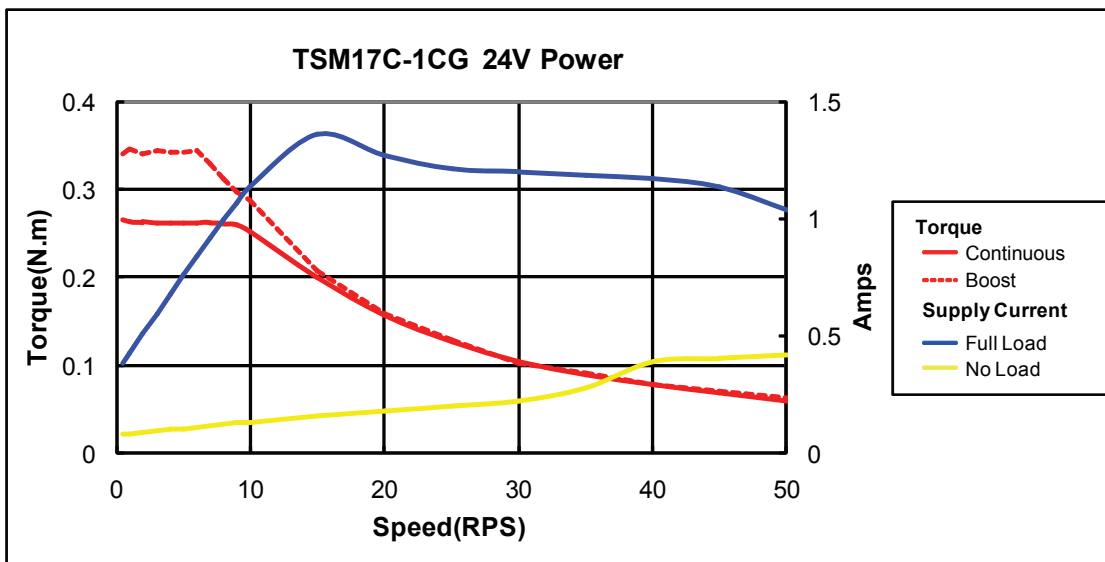
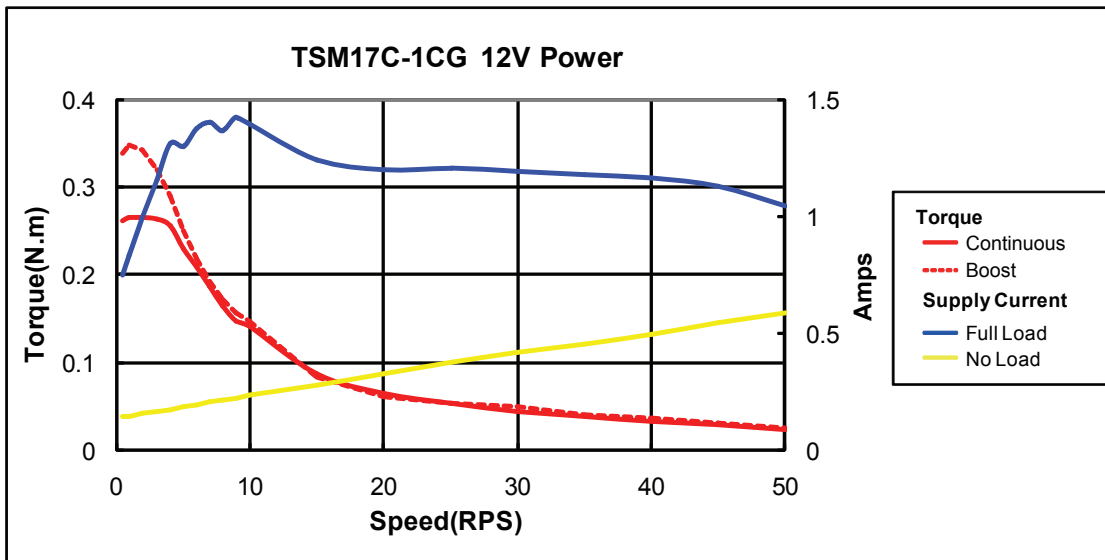

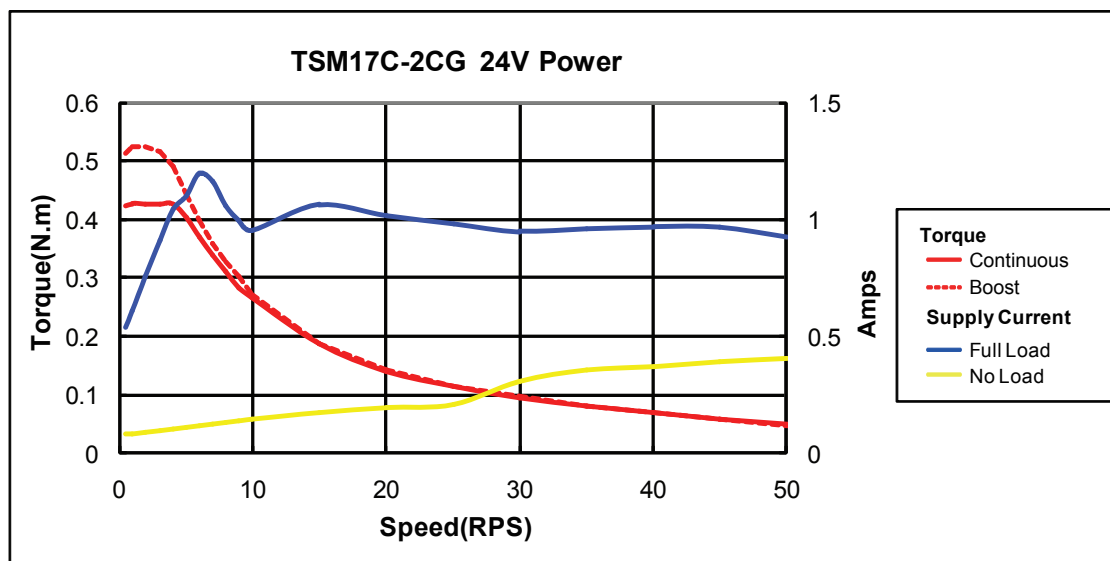
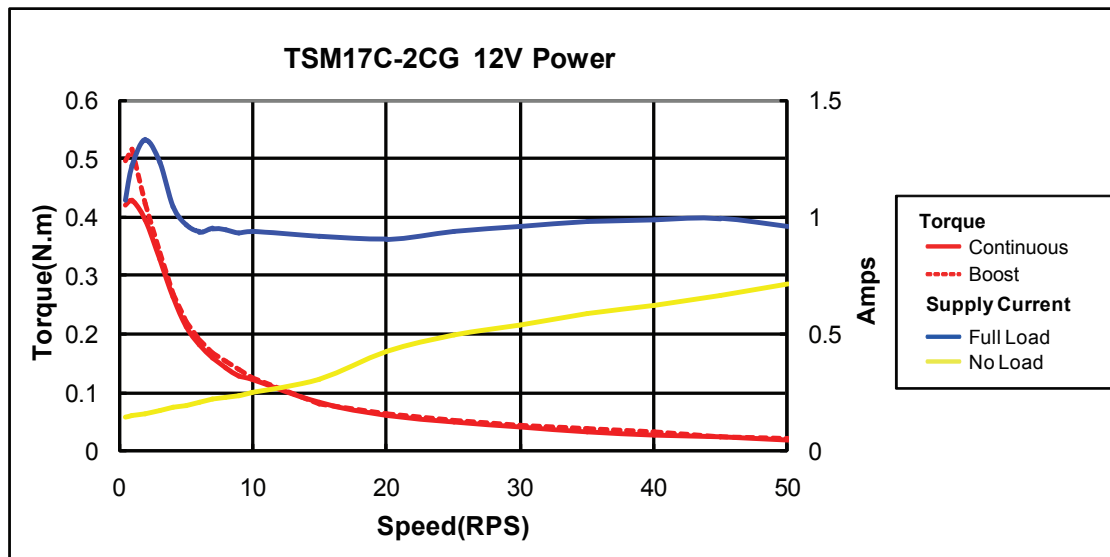
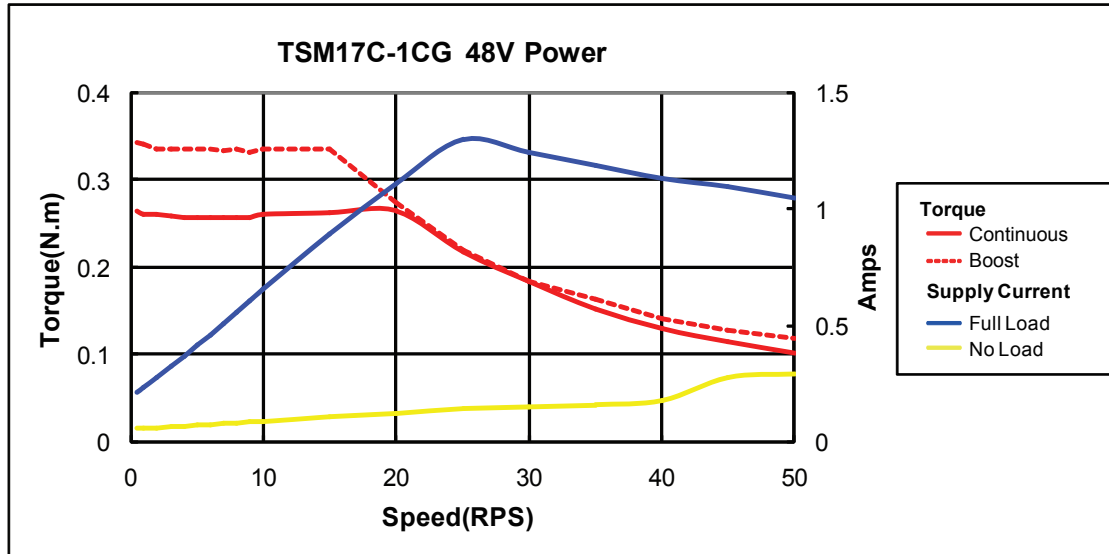

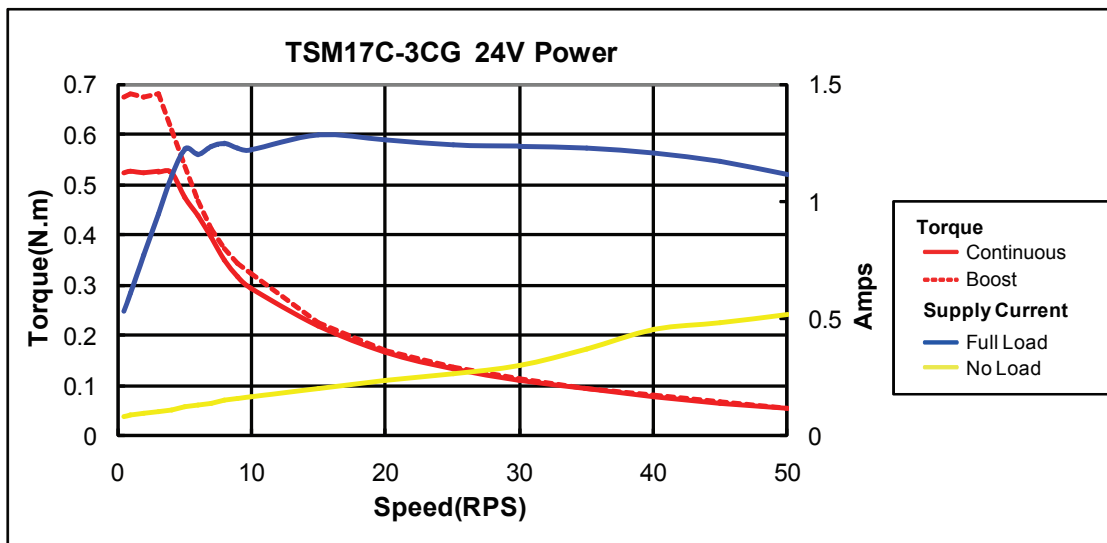
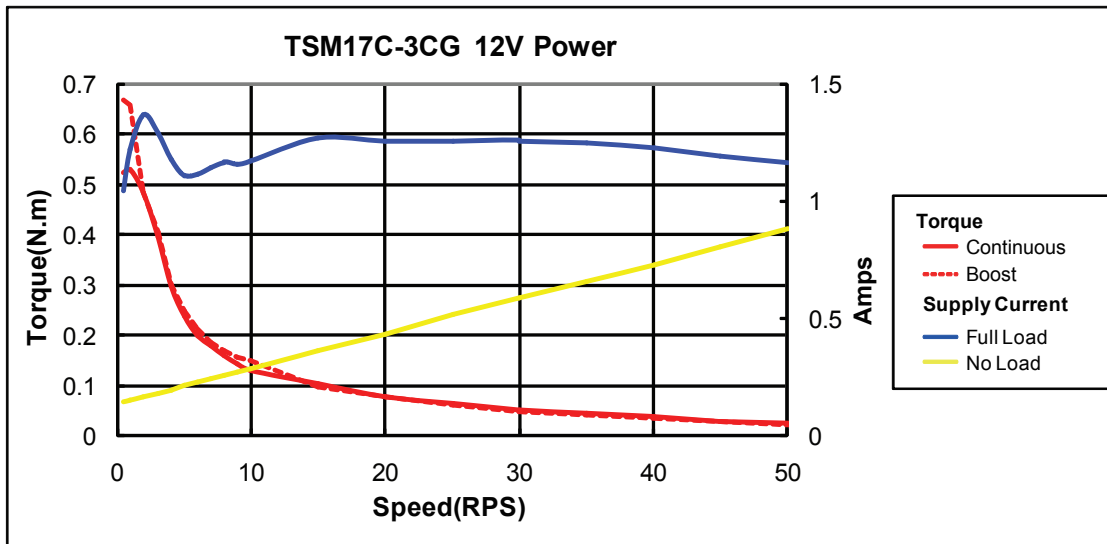
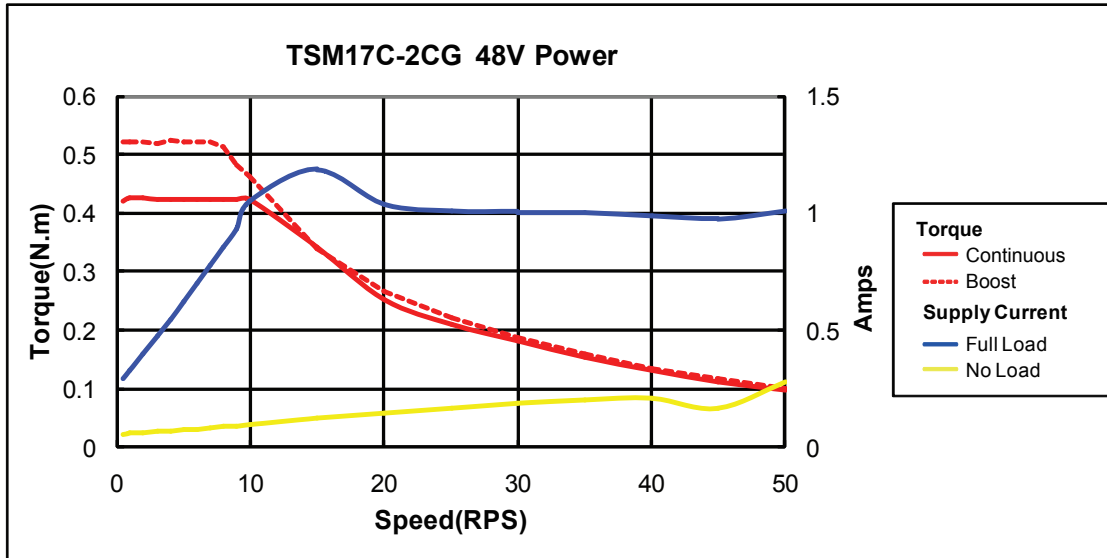

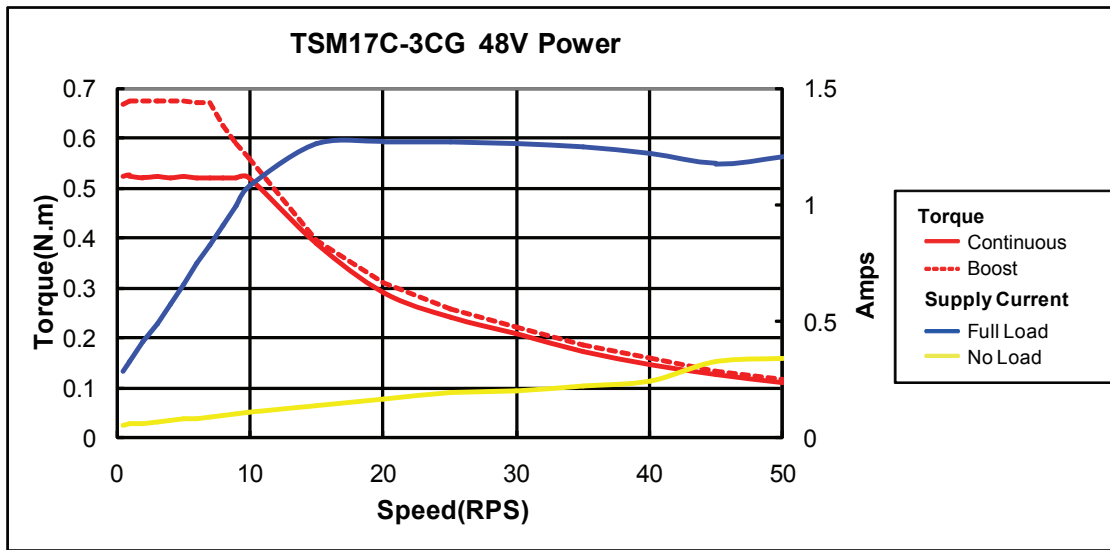

3 Installation/Connections

3.1 Connecting the Power Supply

Use 16 to 20-gauge wire to connect the TSM17C to a power supply. It contains an internal fuse connected to the “+” terminal that is not user replaceable. If a user serviceable fuse is desired, install a 6.3 amp fast acting fuse in line with the “+” power supply lead.



Be careful not to reverse the wires. Reversing the connection may open the internal fuse on the drive and void the warranty.

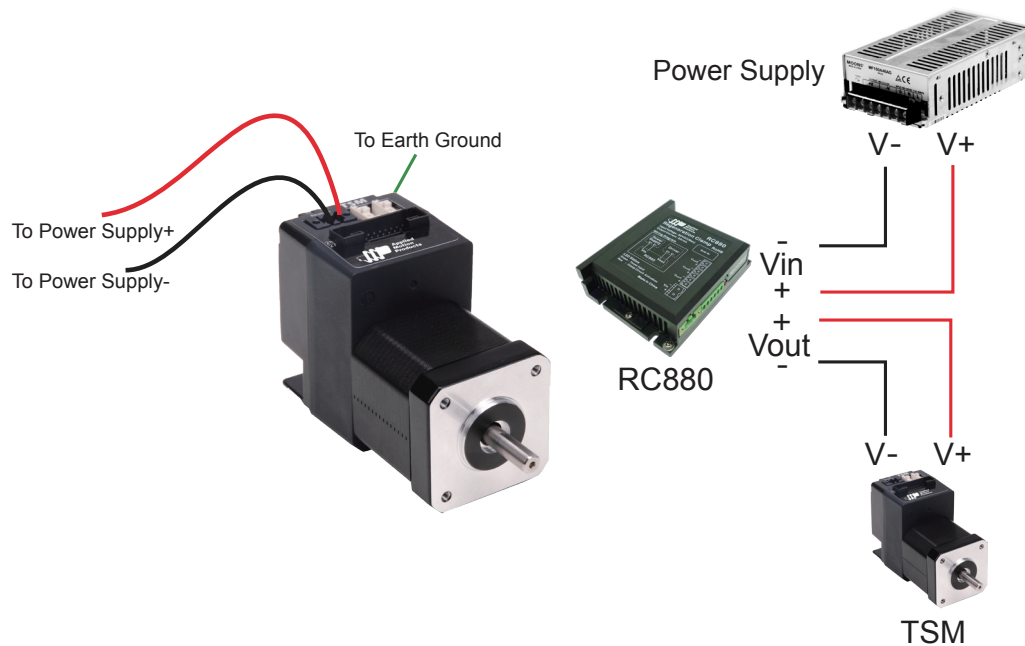

Applied Motion Products offers two matched power supplies for use with the TSM17C. A 24VDC, 150W(P/N PS150A24) and a 48VDC 320W(P/N PS320A48). These power supplies have current over load capability making them ideal for use. (To use with a switch power supplier, a RC880 regen must be connected in system)

The RC880 regeneration clamp is for use where regeneration from the motor may cause damage to the drive. In these cases the RC880 is connected between the drive and power supply and absorbs regenerated energy.

3.2 Connecting the TSM17C Communications

Two standard 5-pin disconnectable crimp style connectors are used for the communications interface of TSM17C, and both of them can be used for RS-232 serial interface and CANopen daisy-chain by different cable included with TSM17C.

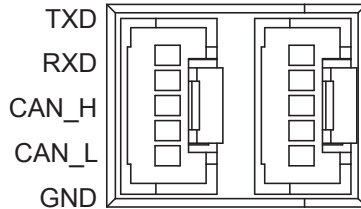

CANopen Connector Diagram

The TSM17C is configured using a combination of rotary switches and an RS-232 serial link, and then may be deployed on a distributed CANopen network. The RS-232 interface is used for configuration, tuning, node ID setting and Q program downloading. The CANopen network should be connected in a daisy-chain fashion, with a 120 ohm terminating resistor at each end of network.

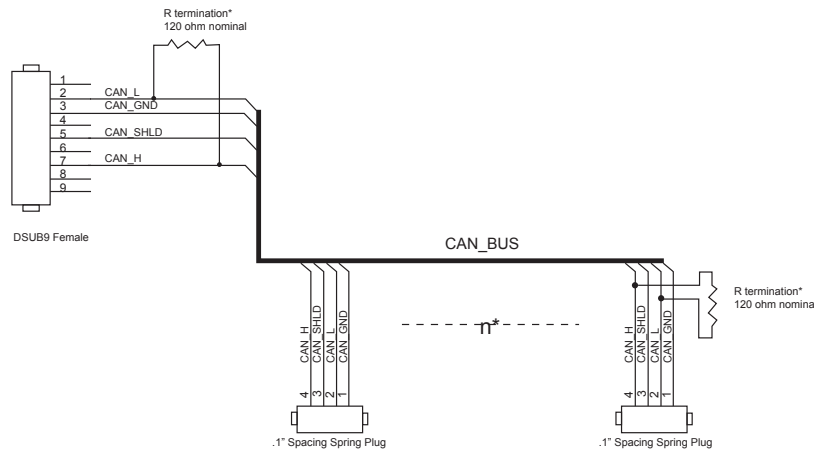

R termination:
Network must be terminated at each end with a 120 ohm resistor.

n:
Cable may be made with up to 127 drive connectors. Termination is only required at each end.

Locate the TSM17C within 1.5 meters of the PC. Plug the DB9 connector of the communication cable that came with the drive into the serial port of the PC. Plug the 5-pin crimp style connector into one of the two appropriate connector on the TSM17C. Secure the cable to the PC with the screws on the DB9 connector.

Note: If the PC does not have an RS-232 serial port, a USB Serial Converter will be needed.

You can contact Applied Motion Products to buy a USB to RS-232 converter.

The RS-232 circuitry does not have any extra electrical “hardening” and care should be taken when connecting to the RS-232 port as hot plugging could result in circuit failure.

3.2.1 Node ID

Each node ID on a CANopen network must have a unique Node ID. The Node ID is configured using a sixteen position switch on the top of the drive to set the lower four bits of the Node ID while the upper three bits are configured by using Step-Servo Quick tuner software. CANopen Node IDs are seven bits long, with a range of 1 - 127, or 0x01 - 0x7F in hexadecimal notation. Node ID 0x00 is reserved in accordance with the CiA 301 specification.

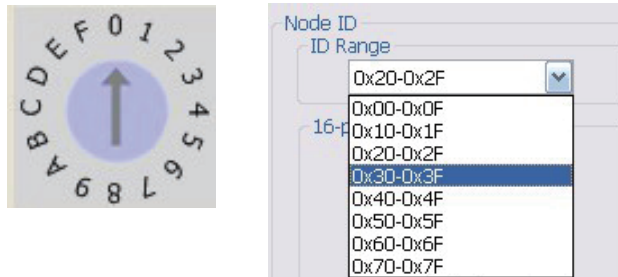

3.2.2 Setting the Btrrate

The CANopen network bitrate is set by the ten position switch on the top of the drive. The bit rate must be the same for all nodes on the CANopen network. Any changes to the bit rate require either a power cycle or a CANopen reset command to take effect.



SW1	Bit Rate
0	1 Mbps
1	800 kbps
2	500 kbps
3	250 kbps
4	125 kbps
5	50 kbps
6	20 kbps
7	12.5 kbps
8	reserved
9	reserved

3.3 Inputs and Outputs

- X1 & X2 are digital inputs for differential or single-ended signal. They are general purpose inputs
- X3 & X4 are software programmable single-ended inputs and can be used for Motor Enable/Disable and Alarm/Fault Reset function input;
- X5 & X6 are digital inputs for single-ended signal. They are general purpose inputs.
- X7 & X8 are digital inputs for differential or single-ended signal. They can be configured by software to be CW/CCW Limit input signal;

3.3.1 Connector Pin Diagram

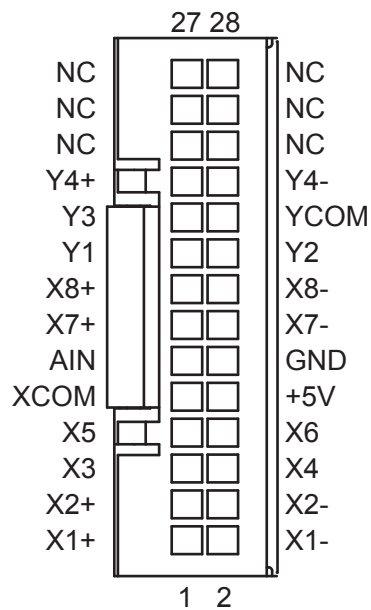

3.3.2 X1 & X2 Digital Input

The TSM17C drives include two inputs: X1 and X2. They accept 5 to 24 volt single-ended or differential signals. The diagrams below show how to connect them to various commonly used devices.

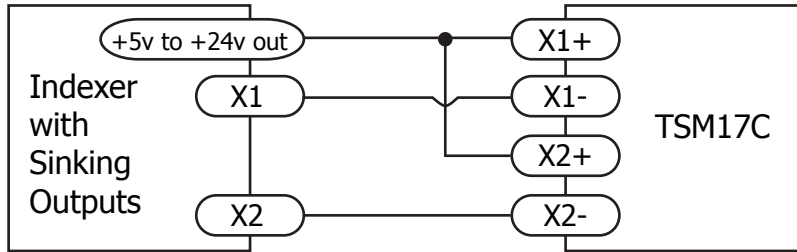

Connecting to Indexer with Sinking Outputs

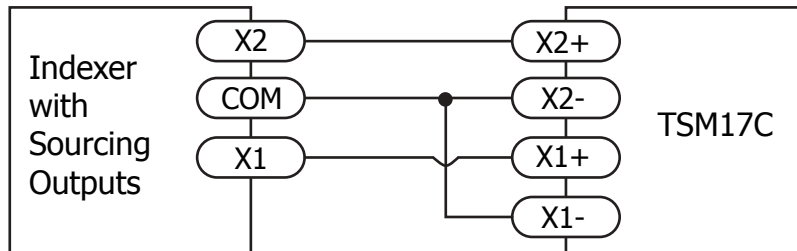

Connecting to Indexer with Sourcing Outputs

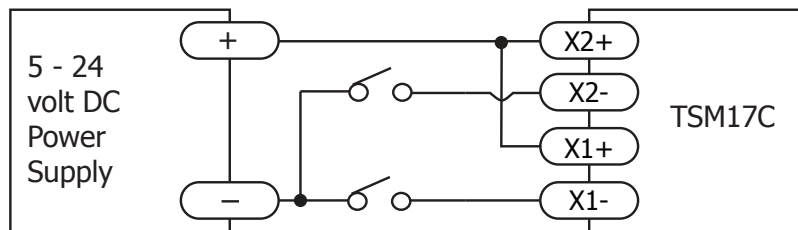

Using Mechanical Switches

3.3.3 X3/X4/X5/X6 Digital Input

X3/X4/X5/X6 input are optically Isolated Single-ended input. They can be used with sourcing or sinking signals, 5 to 24 volts. This allows connection to PLCs, sensors, relays and mechanical switches. Because the input circuits are isolated, they require a source of power. If you are connecting to a PLC, you should be able to get power from the PLC power supply. If you are using relays or mechanical switches, you will need a 5-24 V power supply.

What is COM?

“Common” is an electronics term for an electrical connection to a common voltage. Sometimes “common” means the same thing as “ground”, but not always. In the case of the TSM17 drives, if you are using sourcing (PNP) input signals, then you will want to connect COM to ground (power supply -). If you are using sinking (NPN) signals, then COM must connect to power supply +.

Note: If current is flowing into or out of an input, the logic state of that input is low or closed. If no current is flowing, or the input is not connected, the logic state is high or open.

The diagrams below show how to connect X3/X4/X5/X6 input to various commonly used devices.

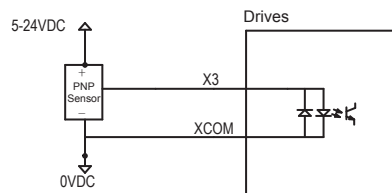
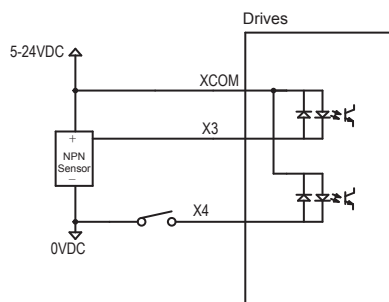
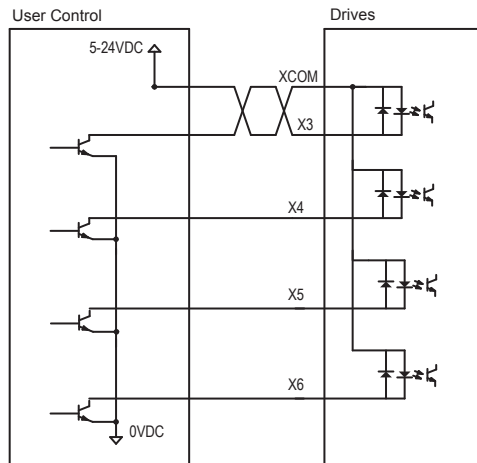

3.3.4 X7/X8 Digital Input

The X7/X8 input are optically Isolated differential input. They are normally used for end of travel limit switches. The diagrams below show how to connect the X7/X8 Inputs to various commonly used devices.

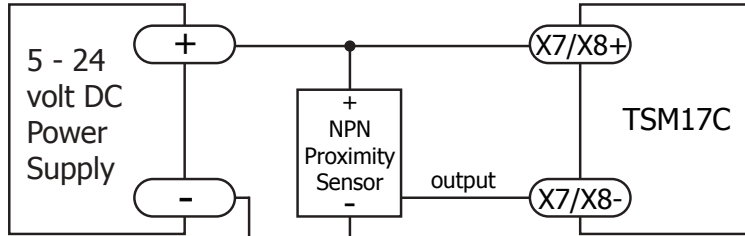

Connecting an NPN type Proximity Sensor to an Input
(when prox sensor activates, input goes low)

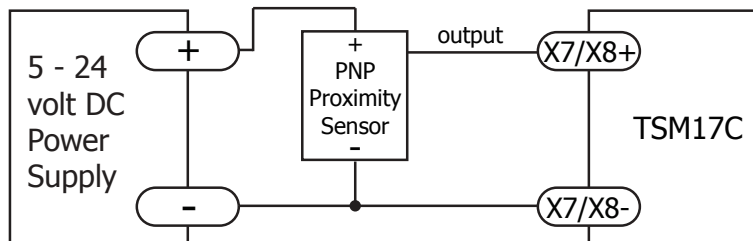

Connecting a PNP type Proximity Sensor to an Input
(when prox sensor activates, input goes high)

3.3.5 Programmable Output Y1/Y2/Y3

TSM17C motors feature three optically isolated digital outputs (Y1/Y2/Y3) with common ground. They can be configured by Step-Servo Quick Tuner software.

- Y1 can be set to signal a fault condition;
- Y2 can be set to indicate whether the motor is in position(dynamic);
- Y3 can be set to control a motor brake.

The output can be used to drive LEDs, relays and the inputs of other electronic devices like PLCs and counters. Diagrams of various connection types follow.

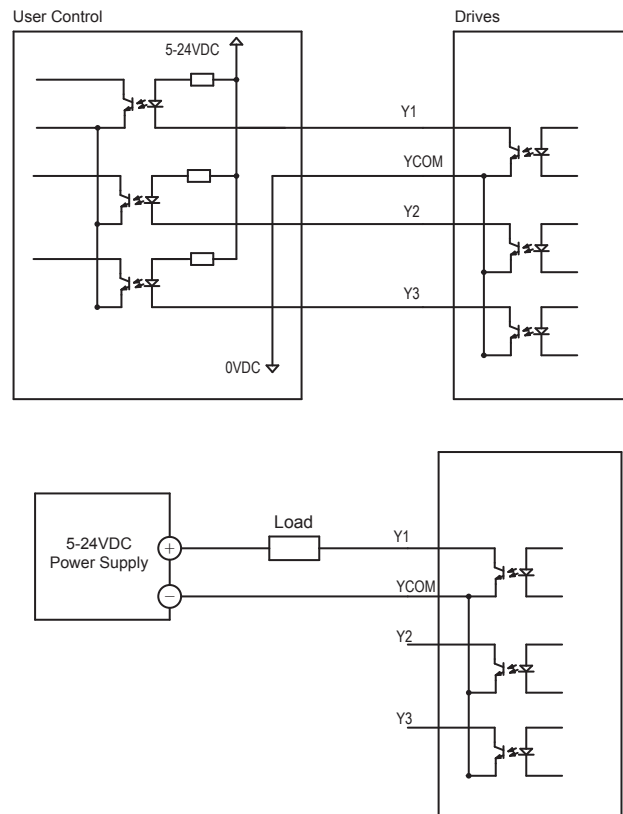

Do not connect the output to more than 30 volts. The current through the output terminal must not exceed 100mA.

3.3.6 Programmable Output Y4

TSM17C motors feature one optically isolated digital output Y4.

The Y4+ (collector) and Y4- (emitter) terminals of the transistor are available at the connector. This allows the output to be configured for current sourcing or sinking.

Y4 can be set to provide an output frequency proportional to motor speed(tach signal), or to provide a timing outout (50 pulses/rev), or to indicate whether the motor is in position(static).

Diagrams of various connection types follow.

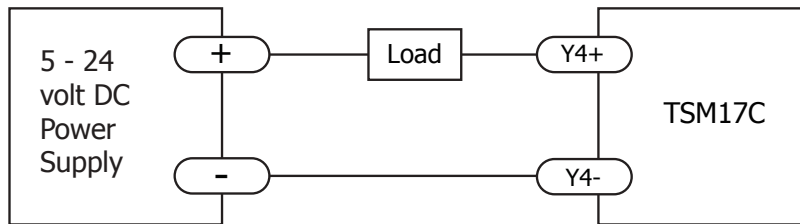

Connecting a Sinking Output

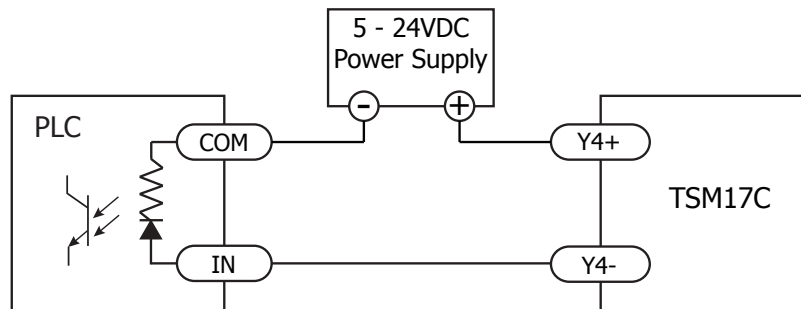

Connecting a Sourcing Output

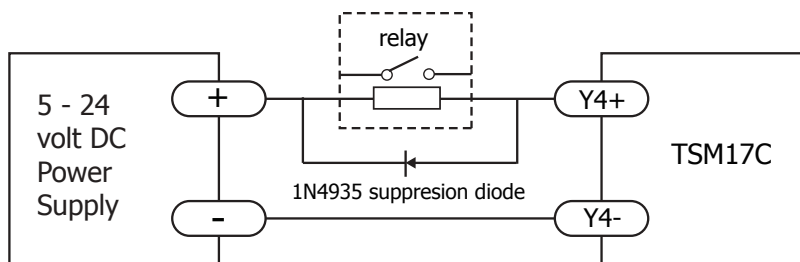

















Driving a Relay

Do not connect the output to more than 30 volts. The current through the output terminal must not exceed 100mA.

4 Troubleshooting

LED Error Codes

The TSM17C uses red and green LEDs to indicate status. When the motor is enabled, the green LED flashes slowly. When the green LED is solid, the motor is disabled. Errors are indicated by combinations of red and green flashes as shown below. This feature can be disabled for certain warnings but not for alarms. See software manual for information on how to do this and which warnings may be masked.

	Code	Error
	Solid green	no alarm, motor disabled
	Flashing green	no alarm, motor enabled
	1 red, 1 green	motor stall (optional encoder only)
	2 red, 1 green	ccw limit
	2 red, 2 green	cw limit
	3 red, 1 green	drive overheating
	3 red, 2 green	internal voltage out of range
	3 red, 3 green	blank Q segment
	4 red, 1 green	power supply overvoltage or excess regen
	4 red, 2 green	power supply undervoltage
	4 red, 3 green	flash memory backup error
	5 red, 1 green	Over current/short circuit
	6 red, 1 green	Open motor winding
	6 red, 2 green	bad encoder signal (optional encoder only)
	7 red, 1 green	communication error
	7 red, 2 green	flash memory error

5 Reference Materials

5.1 Torque-Speed Curves

Note: all torque curves were measured at 20,000 steps/rev.

Note: 2 amp rating is continuous, 3 amp rating is boost

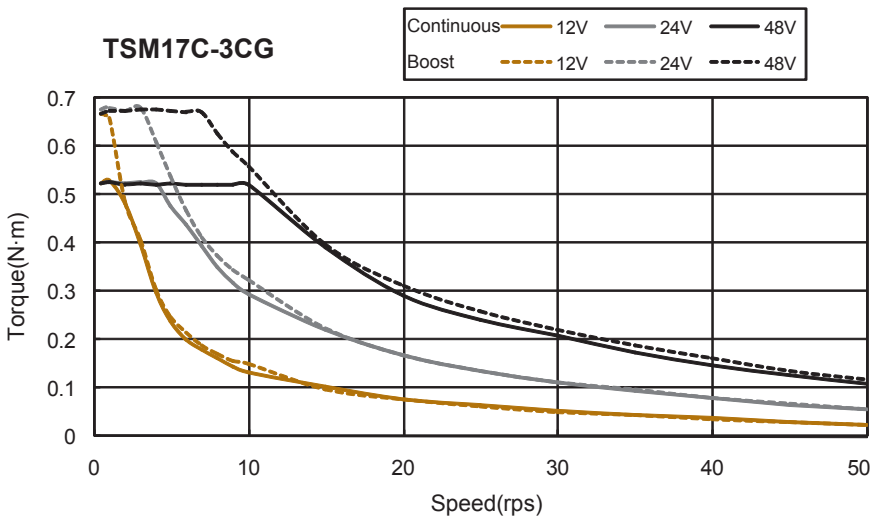
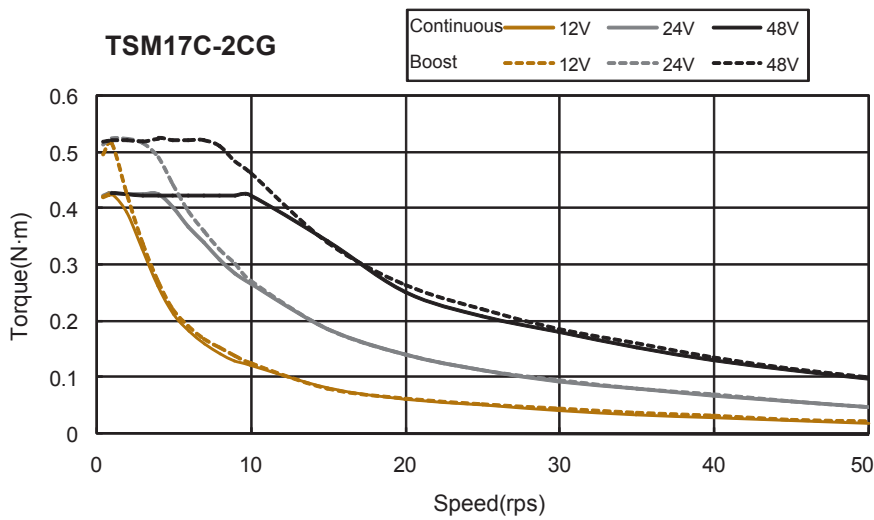
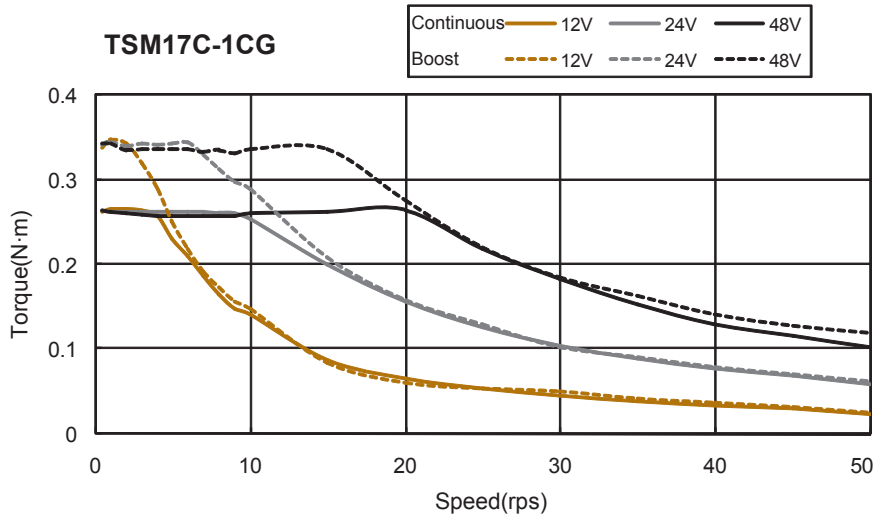

5.2 Mechanical Outlines

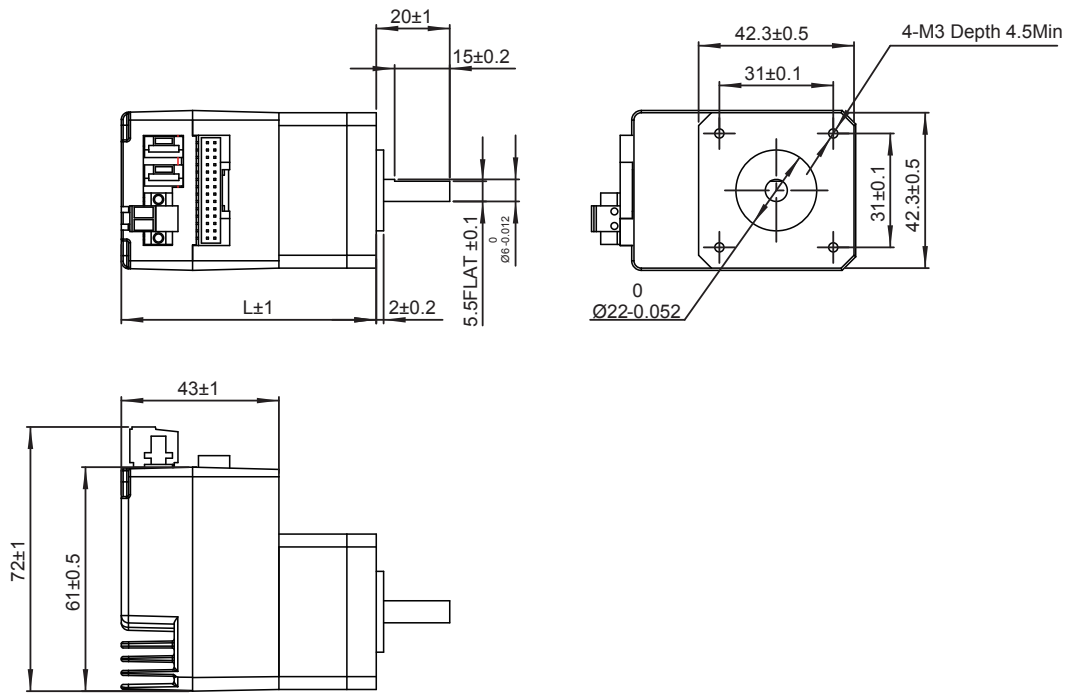

Unit:mm

Model	Length "L"
TSM17C-1CG	69.4
TSM17C-2CG	74.9
TSM17C-3CG	83.4

5.3 Technical Specifications

Power Amplifier	
Amplifier Type	Dual H-Bridge, 4 Quadrant
Current Control	4 state PWM at 20 KHz
Output Torque	TSM17C-1CG: Up to 0.28 N•m Continuous(0.35 N•m Boost) TSM17C-2CG: Up to 0.42 N•m Continuous(0.52 N•m Boost) TSM17C-3CG: Up to 0.52 N•m Continuous(0.68 N•m Boost)
Power Supply	External 12 - 48 VDC power supply required
Protection	Over-voltage, under-voltage, over-temp, motor/wiring shorts (phase-to-phase, phase-to-ground)
Controller	
Electronic Gearing	Software selectable from 200 to 51200 steps/rev in increments of 2 steps/rev
Encoder Resolution	20000 counts/rev
Speed Range	Up to 3600rpm
Filters	Digital input noise filter, Smoothing filter, PID filter, Notch filter
Non-Volatile Storage	Configurations are saved in FLASH memory on-board the DSP
Modes of Operation	CANopen slave node plus stored Q Program execution
Digital Inputs	Digital Inputs Adjustable bandwidth digital noise rejection filter on all inputs X1/X2 : Optically isolated, 5-24 volt differential or single-ended input, Minimum pulse width = 250 ns, Maximum pulse frequency = 2 MHz Function: general purpose input X3/X4/X5/X6 : Optically isolated, 5-24 volt single-ended input, Minimum pulse width = 100 μ s, Maximum pulse frequency = 5 KHz Function: Servo on/off, Alarm/Fault Reset, or general purpose input X7/X8 : Optically isolated, 5-24 volt differential or single-ended input, Minimum pulse width = 100 μ s, Maximum pulse frequency = 5 KHz Function: CW/CCW Limit input, or general purpose input
Digital Output	Y1/Y2/Y3/Y4: Optically isolated, 30V/100mA max Open Collector Output. Function: Alarm/Fault, In Position(dynamic/static), Brake Control, Tach out, Timing out, or general purpose usage
Communication Interface	CANopen & RS-232
Physical	
Ambient Temperature	0 to 40°C (32 to 104°F) When mounted to a suitable heatsink
Humidity	90% Max., non-condensing
Mass	TSM17C-1CG: 280 g TSM17C-2CG: 360 g TSM17C-3CG: 440 g
Rotor Inertia	TSM17C-1CG: 38 g•cm ² TSM17C-2CG: 57 g•cm ² TSM17C-3CG: 82 g•cm ²

6 Contacting Applied Motion Products

404 Westridge Dr.

Watsonville, CA 95076, USA

1-800-525-1609

Tel (831) 761-6555

Fax (831) 761-6544

www.applied-motion.com

