

## Communication Software for Stepper Motor Control Units OMC, TMC, MCC and IXE $\alpha$

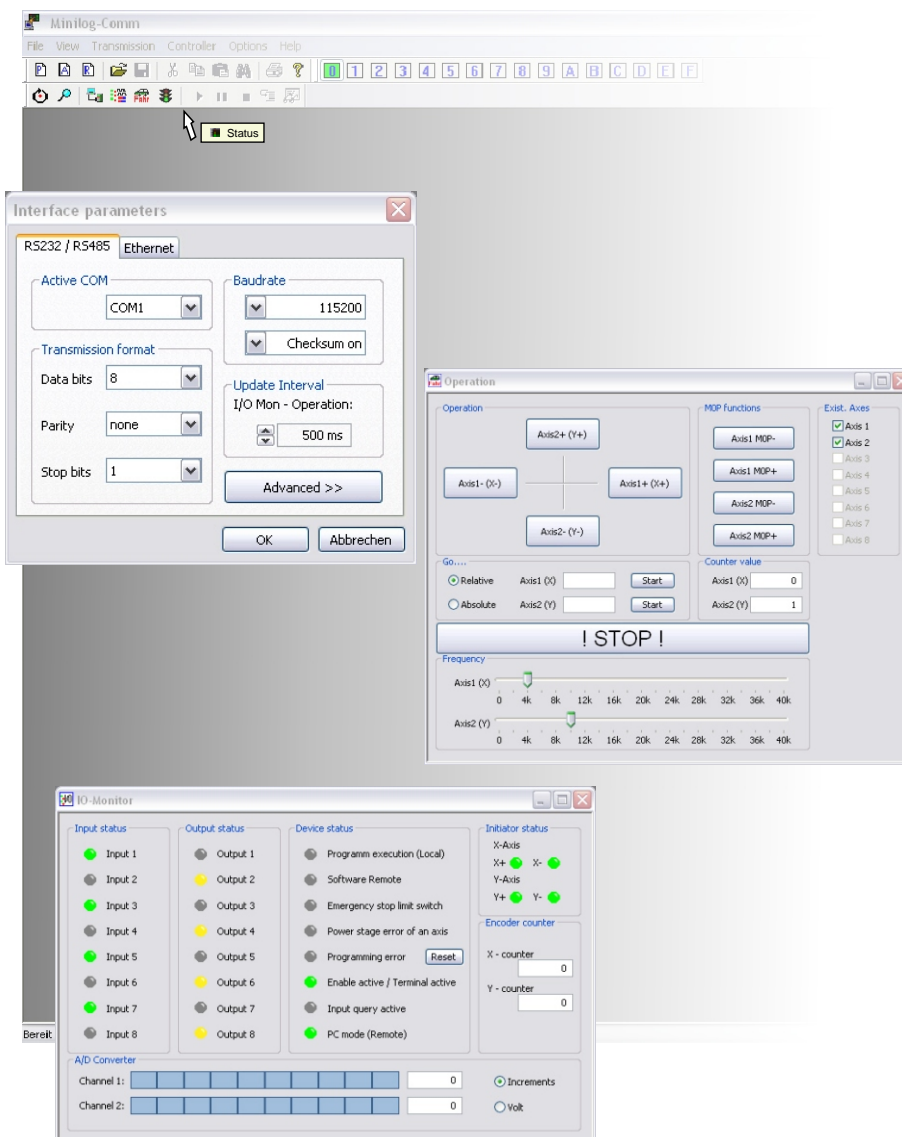



# MiniLog-Comm<sup>®</sup>

## Communication Software for Stepper Motor Control Units OMC, TMC, MCC and IXE $\alpha$

TRANSLATION OF THE GERMAN ORIGINAL MANUAL

© 2010

All rights with:

Phytron GmbH

Industriestraße 12

82194 Gröbenzell, Germany

Tel.: +49 8142/503-0

Fax: +49 8142/503-190

Every possible care has been taken to ensure the accuracy of this technical manual. All information contained in this manual is correct to the best of our knowledge and belief but cannot be guaranteed. Furthermore we reserve the right to make improvements and enhancements to the manual and / or the devices described herein without prior notification.

We appreciate suggestions and criticisms for further improvement. Please send your comments to the following

E-mail address: [doku@phytron.de](mailto:doku@phytron.de)

## Inhaltsverzeichnis

1	What is MiniLog-Comm® ? .....	6	5.6.4	Direct Mode .....	30
2	System Requirements .....	7	5.6.5	Operation.....	31
3	Program Installation .....	7	5.6.6	IO-Monitor .....	32
3.1	How to Install the Program .....	8	5.6.7	Status Monitor (for OMC/TMC and MCC) .....	35
3.2	File Names .....	10	5.6.8	Show Position.....	36
3.3	Update of MiniLog-Comm® .....	10	5.7	The <i>Controller</i> Menu.....	38
3.4	USB Driver.....	10	5.7.1	Autostart Program .....	38
4	The Working Environment Used by MiniLog-Comm® .....	11	5.7.2	Search Controller .....	38
5	The MiniLog-Comm® Menus .....	14	5.7.3	Current Settings (for OMC/TMC and MCC).....	38
5.1	Start and Exit MiniLog-Comm® .....	14	5.7.4	Reset (for OMC/TMC and MCC)	39
5.2	The <i>File</i> Menu.....	14	5.7.5	Firmware Information .....	39
5.2.1	New .....	14	5.7.6	Firmware Update (for OMC/TMC and MCC).....	39
5.2.2	Open.....	19	5.7.7	Password.....	42
5.2.3	Save .....	19	5.8	The <i>Execute</i> Menu (for OMC/TMC and MCC) .....	43
5.2.4	Save as.....	19	5.9	The <i>Options</i> Menu .....	45
5.2.5	Close .....	19	5.9.1	Interface Parameters.....	45
5.2.6	Print .....	19	5.9.2	Controller Type.....	49
5.2.7	Side View.....	19	5.9.3	Language .....	49
5.2.8	Print Installation .....	20	5.9.4	Server.....	50
5.2.9	Exit.....	20	5.10	The <i>Windows</i> Menu.....	51
5.3	The <i>Edit</i> Menu .....	20	5.10.1	Cascading Windows.....	51
5.4	The <i>View</i> Menu.....	21	5.10.2	Tile Windows .....	52
5.5	The <i>Draw</i> Menu .....	21	5.10.3	Place Symbols.....	52
5.5.1	Drawing and Manipulating Objects.....	22	5.10.4	Save/Load Position .....	53
5.5.2	Parameter Line .....	23	5.11	The <i>Help</i> Menu.....	53
5.5.3	Parameter Circle.....	24	5.11.1	About MiniLog-Comm® .....	53
5.5.4	Desktop Functions.....	24	5.11.2	Help .....	53
5.5.5	Example.....	25	6	Error Messages .....	54
5.6	The <i>Transmission</i> Menu .....	26	7	Copyright and Limitation of Warranty .....	55
5.6.1	Send .....	26	8	Index .....	56
5.6.2	Receive.....	28			
5.6.3	Delete .....	29			

## 1 What is MiniLog-Comm<sup>®</sup> ?

---

MiniLog-Comm is a WINDOWS program to operate the phytron stepper motor controllers OMC, TMC, MCC-1, MCC-2, MCC-2-LIN and IXE $\alpha$  by means of PC. Even without programming experience you can easily handle the communication with phytron controller systems after only a short learning period.

You only have to connect the phytron controller to the interface connector of your PC, and you have to install the MiniLog-Comm software according to the instructions in this manual - that's all.

MiniLog-Comm supports the edition of MINILOG-programs for the phytron controllers OMC, TMC, MCC, MCC-2, MCC-2-LIN and IXE $\alpha$ . In addition, MiniLog-Comm handles and stores MINILOG-programs, parameter and register sets of the controllers.

### **The Main Features of MiniLog-Comm on One View**

- Desktop with pull-down menus and mouse support
- Hotkeys for frequently used instructions
- Menu dialog in 2 languages (German and English)
- Dynamic allocation of PC resources, that means, MiniLog-Comm will only occupy the memory space needed in each moment.
- Program editor for an unlimited number of program lines
- Register editor for 1000 numbers of register
- Parameter editor for up to 8 stepper motor axes
- You can edit and store up to 7 comment lines of unlimited length to each MINILOG program line and each MINILOG register. The comment lines can be moved individually.
- Operating facility in program test mode: Single step mode, program operating with break point setting and error acknowledge message
- Simple and fast parameter settings of the stepper motor controllers
- Several programs can be transmitted in single mode by MiniLog-Comm to the controller or from the controller to MiniLog-Comm.
- OMC and TMC controllers are programmable in stand-alone, master-slave or bus mode.
- MCC controllers can be programmed in stand-alone mode or bus mode.

## 2 System Requirements

MiniLog-Comm can be used on PCs with the following minimum features:

- Pentium 100 MHz
- Operating system Windows<sup>®</sup> 2000, XP, Vista or 7
- 32 MB RAM free memory minimum
- Windows Explorer 5
- Mouse
- CD-ROM drive, if program is installed from CD
- The following interfaces are necessary for controller connection:

OMC/TMC and IXE $\alpha$	RS 232
MCC-1/MCC-2/MCC-2-LIN	RS 232, RS 422 / RS 485 (4-wire), USB or Ethernet

## 3 Program Installation

The following folders are saved on the CD:

English	Includes the files for a setup in English
German	Includes the files for a setup in German

## 3.1 How to Install the Program

1. Put the program CD into the CD-ROM drive.
2. If the autostart program doesn't start automatically, open the phytron installation program [CD-ROM-address]\Autostart.exe by mouse click.
3. Phytron's installation program opens the following menu:



Start the MiniLog-Comm installation program by mouse click through the autostart program.

4. The installation program copies the files into the RAM after program start.
5. The screen shows the following information:



Fig. 1: Setup program for MiniLog-Comm



6. Please click on **Next>** and the following information is on screen:

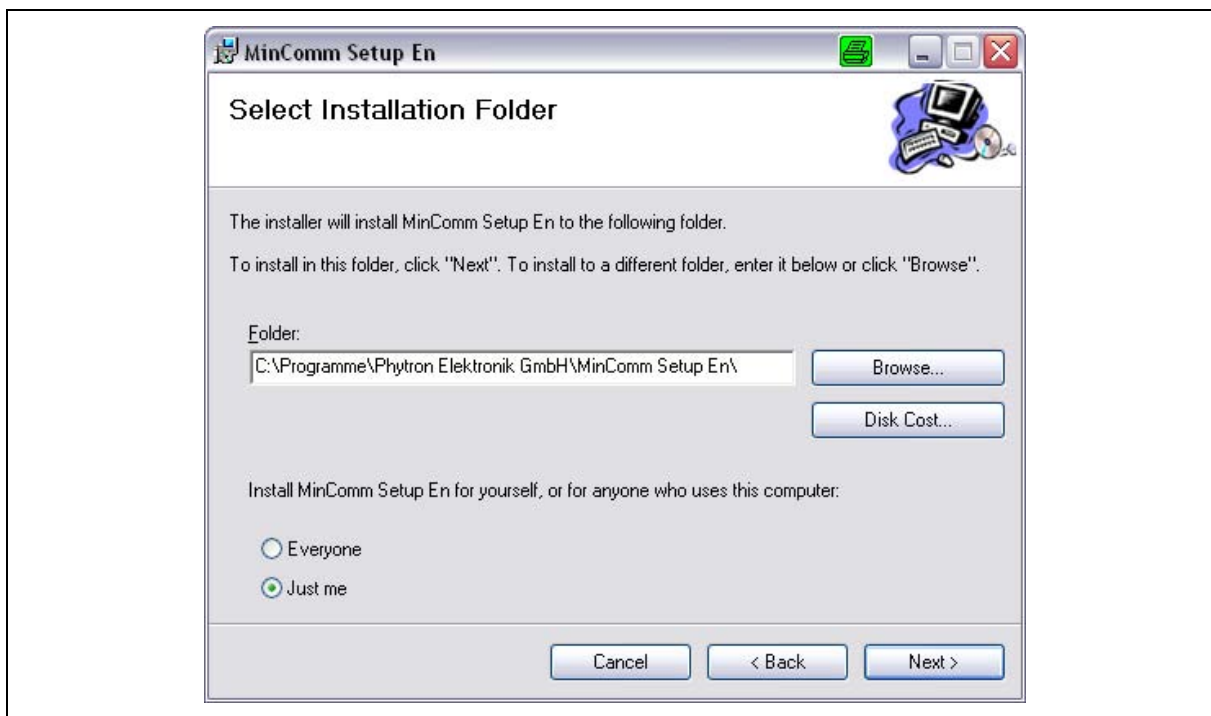

Fig. 2: Setup start for MiniLog-Comm

7. **c:\Programs\Phytron GmbH\Minilog-Comm** is the standard directory of MiniLog-Comm. Another directory can be selected with **Browse**. Click on **Next>** to start the installation.
8. The files will be stored into the defined directory, some files will be stored into the Windows directory.
9. When the message *MiniLog-Comm successfully finished* is on desktop, the installation has been successfully finished. Finish by **Close**.
10. Remove the CD from the CD-ROM drive.
11. Select Programs -> Phytron GmbH -> Minilog-Comm for starting MiniLog-Comm.

**Remark:**

**If you have got the MiniLog-Comm files on another way (e. g. E-mail), the program installation can be done like in chapter 3.1 (beginning at item 2). Instead of CD-ROM drive select the corresponding directory, on which the file SETUP.exe is stored.**

## 3.2 File Names

---

After installation the following files are stored in the directory:

Minilog-Comm.exe	Program MiniLog-Comm
MinilogComm-Help.chm	Help file
Folder Parameter	For MCC: D_MCC.par : Parameter file in German E_MCC.par : Parameter file in English  For OMC and TMC: D_OMC.par : Parameter file in German E_OMC.par : Parameter file in English  For IXE $\alpha$ : D_Alpha.par : Parameter file in German E_Alpha.par : Parameter file in English

## 3.3 Update of MiniLog-Comm®

---

If you want to install an update of a MiniLog-Comm copy, the installation program automatically deletes the old version before installing the new.

## 3.4 USB Driver

---

When the MCC is connected to the PC by USB-interface, the USB drivers of the phytron-CD have to be installed on the PC (see MiniLog manual).

## 4 The Working Environment Used by MiniLog-Comm®

After the successful program start of MiniLog-Comm the desktop will show up like in Fig. 3:

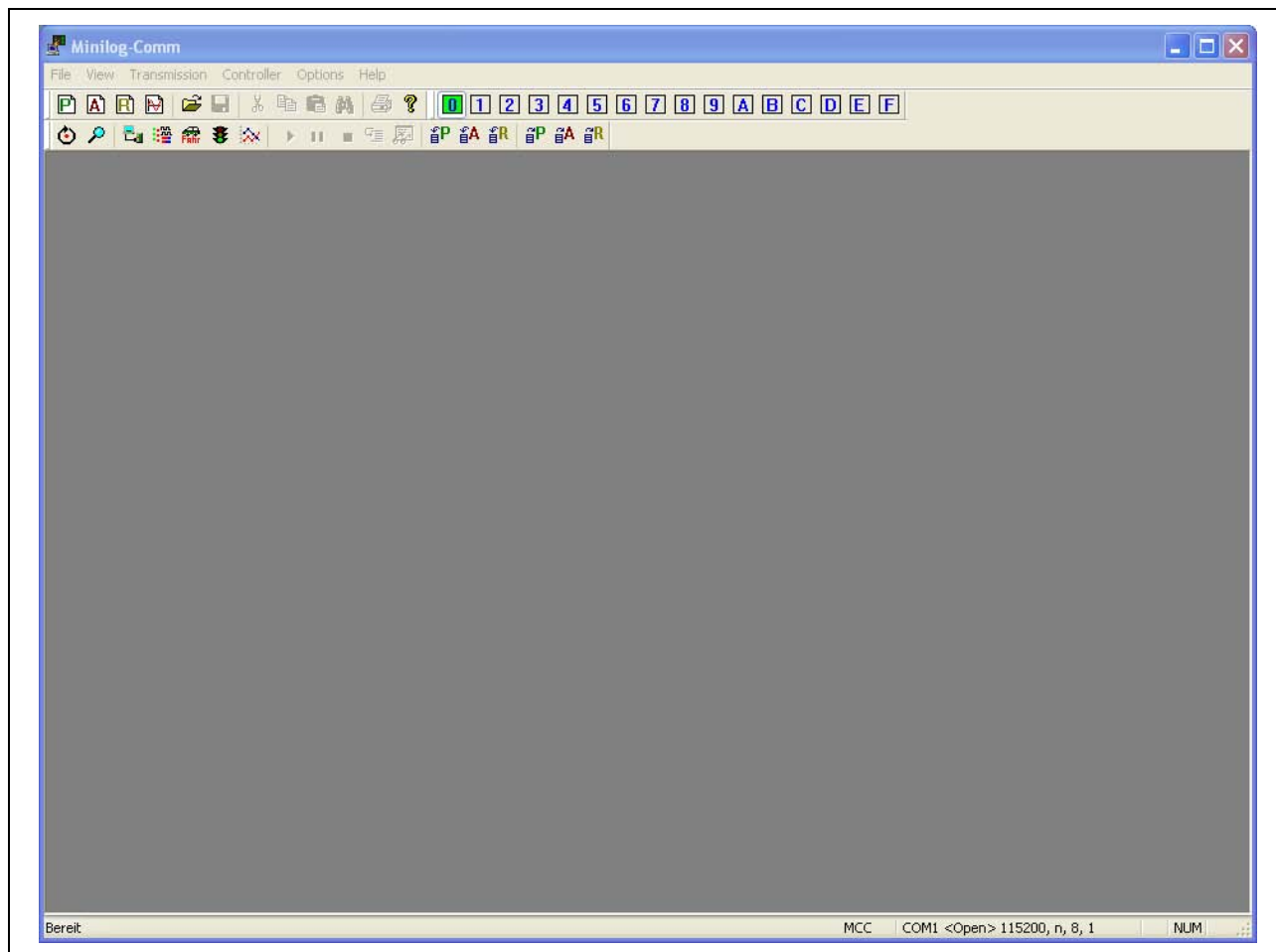





























Fig. 3: Desktop after program start

The working environment of MiniLog-Comm consists of several main components:

1. The selection menu in the top line on the desktop:  
File, View, Transmission, Controller, Options, Help
2. Toolbars: Selection of some instructions and device address (0 to 9 and A to F) with icons (see table)
3. The working area
4. The status bar line at the bottom of the desktop: Interface parameters (COM port, baud rate) and controller type

Icon	Signification	Which bar
	Write new program	Toolbar
	Write new register	Toolbar
	Write new parameters	Toolbar
	Write new Motion Creator	Toolbar
	Send program	Communication bar
	Receive program	Communication bar
	Send register	Communication bar
	Receive register	Communication bar
	Send parameter	Communication bar
	Receive parameter	Communication bar
	Open program file	Toolbar
	Save file	Toolbar
	Print file	Toolbar
	Cut	Toolbar
	Copy	Toolbar
	Insert	Toolbar
	Search	Toolbar
	Open Help menu	Toolbar
	Undo the last instruction	Toolbar
	Redo the last instruction	Toolbar
	Dialog Open Direct mode	Communication bar
	Dialog Open Operation	Communication bar
	Dialog Open IO-Monitor	Communication bar
	Dialog Open Status monitor	Communication bar
	Show current x-y position	Communication bar
	Start Single step mode of controller program	Communication bar
	Start controller program	Communication bar
	Interrupt controller program	Communication bar
	Stop controller program	Communication bar
	Query of variables during program sequence	Communication bar
	Controller Reset	Communication bar

	Search controller	Communication bar
	Choose an object (line, segment)	Special toolbar
	Zoom the desktop	Special toolbar
	Move the desktop	Special toolbar
	Draw a line from the last data point to the mouse cursor.	Special toolbar
	Draw a 90° segment clockwise, which can be parameterized afterwards.	Special toolbar
	Draw a 90° segment counterclockwise, which can be parameterized afterwards.	Special toolbar
	Insert a line in a present object.	Special toolbar
	Insert a curve (90° segment) clockwise, which can be parameterized.	Special toolbar
	Insert a curve (90° segment) counterclockwise, which can be parameterized.	Special toolbar

**i** You`ll find the MiniLog instructions in the MINILOG manual!

## 5 The MiniLog-Comm<sup>®</sup> Menus

---

In this chapter you will find all you need to start and to leave MiniLog-Comm as well as a detailed description of each menu instruction, dialog box, switch etc.

### 5.1 Start and Exit MiniLog-Comm<sup>®</sup>

---

Select **Start / Programs / Phytron GmbH / Minilog-Comm** to start the program by click on the left mouse button.

Use the menu instruction **File / Exit** to leave MiniLog-Comm. MiniLog-Comm displays a warning message if there are unsaved data.

### 5.2 The *File* Menu

---

In the **File** menu you will find instructions to open files, to create new files, to save changed files, to print files and to exit MiniLog-Comm.

#### 5.2.1 New

---

**File / New** submenu selects the editor type, if you want to create a new window on the desktop.

MiniLog-Comm fixes the names: program editor 'Programxx.apr', parameter editor Parameterxx.apa or register editor 'Registerxx.are' (xx stands for a number from 1 to 99). The files \*.apr, \*apa and \*are are only temporary. The program asks you for a new file name in order to save the data.

We don't recommend using ,Program', ,Parameter' or ,Register' as a definitive file name.

## Program Editor

The program editor opens and creates programs for the controller (\*.apr).

A new program can be created via the icon  or the menu **File / New / Program**.

The editor in table form has three columns:

Line number	Program code	Comment
-------------	--------------	---------

Insert the text in the appropriate cell, an already existing text will be overwritten.

Shortcut	Meaning
[ENTER] or left mouse button	Edit the marked cell (edit mode)
[ENTER] in the last program line	Add a new line
[ESC] in the edit mode	Cancel the input
[STRG]+[ENTER]+marked line	Insert a new line above the marked one
[STRG]+[Y]	Delete the marked line
[TAB] or [STRG]+arrow keys or click to another cell	Jump into the next or the selected column

Comment column:

It's possible to enter several lines in the comment column.

The size of the cell is automatically adapted to the text content.

Shortcut	Meaning
[ENTER]	Jump into the next line of the input field
[TAB] or [STRG]+arrow keys or click to another cell	Leave the comment line
[STRG]+[ENTER]	Move the comment one line downwards <b>Remark:</b> No program lines are added. If a comment is in the last line it will be deleted!
[STRG]+[Y]	Delete the comment (has no influence to the program)

## Parameter Editor

The program editor opens and creates programs for the controller.

A new program can be created via the icon  or the menu **File / New / Parameter**.

If you create a new parameter editor window, the parameters for one axis are automatically set using the default parameter file. These values can easily be changed.

A new parameter editor for another axis is created with **Edit / Add Parameterset** or the “right mouse button” in the context menu. The parameter editor can include parameter sets for maximum 8 axes.

**Edit / Remove Parameterset** or the “right mouse button” in the context menu deletes the parameter set.

The first parameter set (axis 1) can't be deleted, because minimum one axis must exist.

## Register-Editor

The register editor shows the registers of a controller or an open file.

It is started by the icon  or via menu **File / New / Register**. The functionality is similar to the program editor.

Also lines can be inserted or deleted by the shortcuts. Unlike to the program editor only **one** comment line can be inserted.

**Important:** The editor can create a random number of registers, but the controllers have limited numbers. All registers above the numbers of the controller register are not transmitted.

You'll find the exact number of your controller registers in the controller's manual.



## Motion Creator

The submenu **File / New / Motion Creator** is used to create two-dimensional movement diagrams by drawing lines or circles without any programming effort.

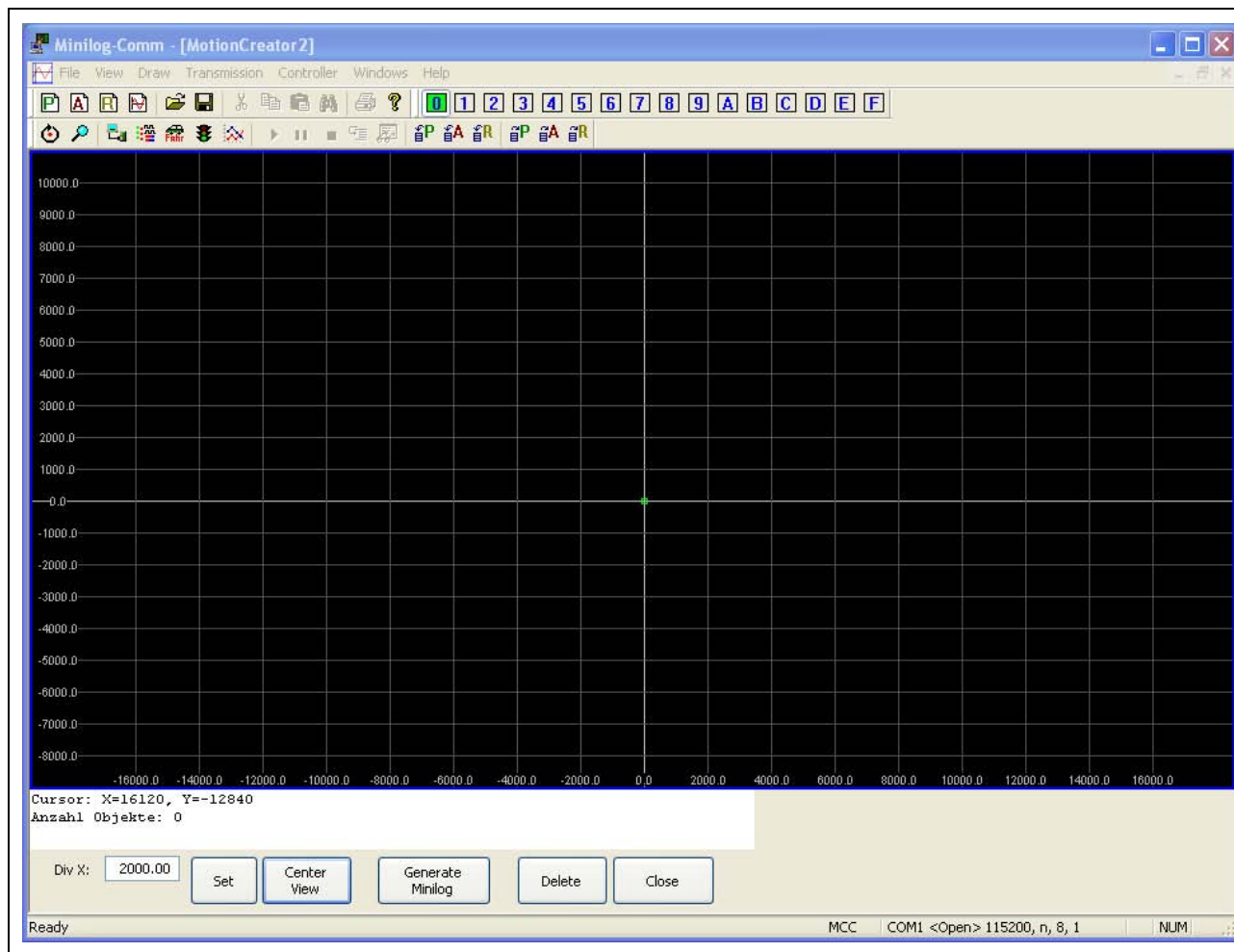

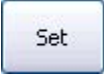



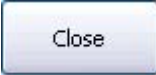

Fig. 4: Motion Creator

The green square shows the present position of the axis. In the example above the counter of the x and the y axis is zero. This is the bench mark of the first drawing function.

## Function of the buttons:

	The X axis is divided into grid points with the specified value. The divisor for the Y axis is calculated automatically by $\frac{1}{2} X$ . E. g.: if the divisor X=1000, the graticule of the Y axis is 500 (see also Fig. 4).
	The changes entered at divisor X are accepted and shown.
	X and Y zero lines are centered for the view.
	The MiniLog code is generated from the graphic. An editor opens, where the code can be edited, stored and transmitted to a controller.
	The total graphics are deleted!
	The window is closed. If the graphics have been changed, you are asked for saving.

The functions of the **Motion Creator** are executed in the **Draw** menu. (See chap. 5.5)

## 5.2.2 Open

---

**File / Open** submenu opens a dialog box to select a file. First, you are asked to select the file type:

*.apr	Program files	Program files on the data medium
*.apa	Parameter files	Parameter files on the data medium
*.are	Register files	Register files on the data medium
*.mcf	Motion Creator files	Motion Creator files on the data medium
*.*	All files	All files on the data medium

MiniLog-Comm automatically selects the right editor (program, parameter or register) during file loading.

## 5.2.3 Save

---

**File / Save** stores the data from the active editor window into a file.

## 5.2.4 Save as

---

**File / Save as** defines a new file name for the data that is edited in the current editor window, or stores the data with the same file name but into another directory or drive.

## 5.2.5 Close

---

The file in the active editor is closed with **File / Close**. If files aren't saved you will be asked to save them. MiniLog-Comm remains open.

## 5.2.6 Print

---

**File / Print** opens the specific Windows print submenu where the printer type and the print properties are selected.

## 5.2.7 Side View

---

**File / Side View** shows the print preview.

## 5.2.8 Print Installation

---

**File / Print Installation** enables you to set the different print parameters (e.g. panel-/landscape format...).

## 5.2.9 Exit

---

**File / Exit:** MiniLog-Comm is finished. If there are still unsaved files, you will be asked to save them by MiniLog-Comm.

## 5.3 The *Edit* Menu

---

The **Edit** menu is a program editor to change the open file. The edit functions depend on the file type:

Program and register files	Cut, delete, copy or insert and cancel
Parameter files	Add and delete parameter set.

The **Search** menu starts from the top of the text and searches for the input text in program or comment lines. The corresponding word is marked in bold highlighted after a successful search.

If you click on **Search** again, the search of the input text is repeated throughout the program or comment lines. Click on **Replace** to replace the text.

### **Important:**

You can insert program lines in the program editor by pressing STRG **[ENTER]**. To insert comment lines (up to 7) press **[ENTER]**. Quit these lines by pressing TAB.

## 5.4 The View Menu

In **View** menu the display of the bars is defined.  
The displayed bars are marked by ✓ .

<b>Toolbar</b>	
<b>Statusbar</b>	Ready <span style="float: right;">COM2 &lt;Open&gt; 9600, n, 8, 1</span>
<b>Addressbar</b>	
<b>Communication bar</b>	
<b>Special Toolbar</b>	

The **View / Font** submenu is only displayed, if the program files are open. Program text can be defined by font, face and size.

## 5.5 The Draw Menu

The Motion Creator has the following functions in the **Draw** menu:

Icon	Function	Meaning
	Selection	Choose an object (line, segment).
	Zoom	Zoom the desktop.
	Move	Move the desktop.
	Draw line	Draw a line from the last data point to the mouse cursor.
	Draw CW curve	Draw a 90° segment clockwise, which can be parameterized afterwards.
	Draw CCW curve	Draw a 90° segment counterclockwise, which can be parameterized afterwards.
	Insert line	Insert a line in a present object.
	Insert CW curve	Insert a curve (90° segment) clockwise, which can be parameterized.
	Insert CCW curve	Insert a curve (90° segment) counterclockwise, which can be parameterized.

## 5.5.1 Drawing and Manipulating Objects

Select the suitable object via special toolbar for object drawing. Different functions are available dependent of the controller (see controller manual).

The beginning of a curve/line is marked by a green, the end by a red cross. This indicates the driving direction (from green to red), in which the curve/line is traced by the controller.

All circular motions have the following definition:

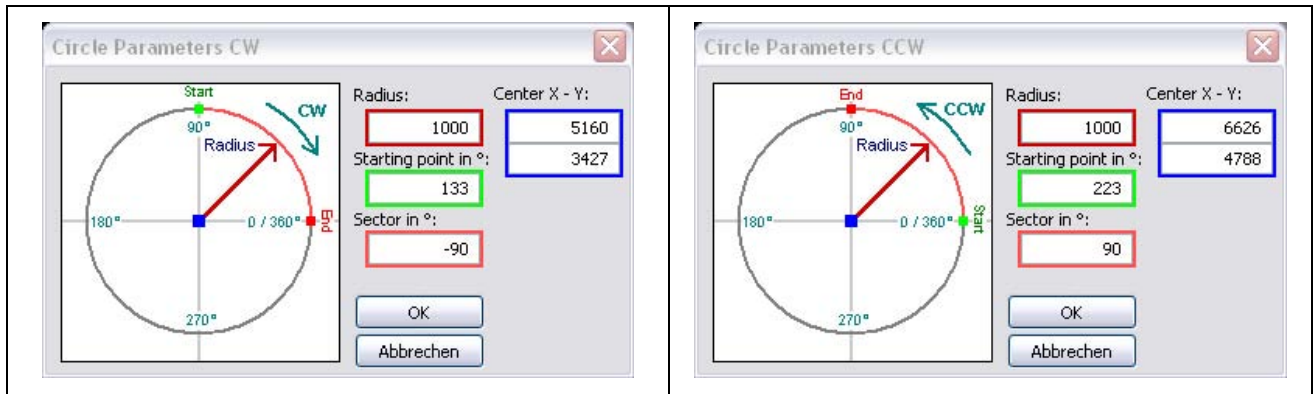











Fig. 5: clockwise (CW)

Fig. 6: counterclockwise (CCW)

	<p>This function marks the object by clicking the object (line or circle). Different functions are available:</p> <ul style="list-style-type: none"> <li>- move an object,</li> <li>- insert new objects at the starting and final point,</li> <li>- parametrize the object with a double click on the object and start the parameter dialog. Different dialogs are opened dependent on the object (line or circle).</li> </ul>
	<p>You can draw a line from the final point of the last object up to the mouse cursor by clicking the left mouse button. Releasing the mouse button creates the object. Holding the mouse button can move the final point of the line to a determined position.</p>
	<p>This button creates a 90° segment which is driven clockwise. The radius of the segment has the default value of the Y scale. The starting point of the circle depends on the previous object.</p>
	<p>A 90° segment counterclockwise is created, see above.</p>

	<p>A line at the starting or final point of a circle or split up a line is inserted.  <u>Procedure:</u>                  Mark the object to be inserted.  <b>Insert a line to a circle:</b> click on the start or end of the marked circle.  <b>Split up a line:</b> mark the line and click to the point, where the new line starts.                  The old line is splitted up and the red marker can be moved by the mouse.</p>
 	<p>Insert a 90° segment by selecting one of these buttons.  <u>Procedure:</u>                  Mark the object, where the circle should be added. A click on  or  and on the start or limit mark of the object inserts a 90° segment.</p>
<p><b>Delete single objects</b></p>	<p>Mark the object.                  The button <b>[Remove]</b> deletes the selected object.                  The starting point of the followed object is the final point of the previous object.                  The selected object is deleted from the internal object table of the program.</p>

### 5.5.2 Parameter Line

Double click to a line opens this dialog:

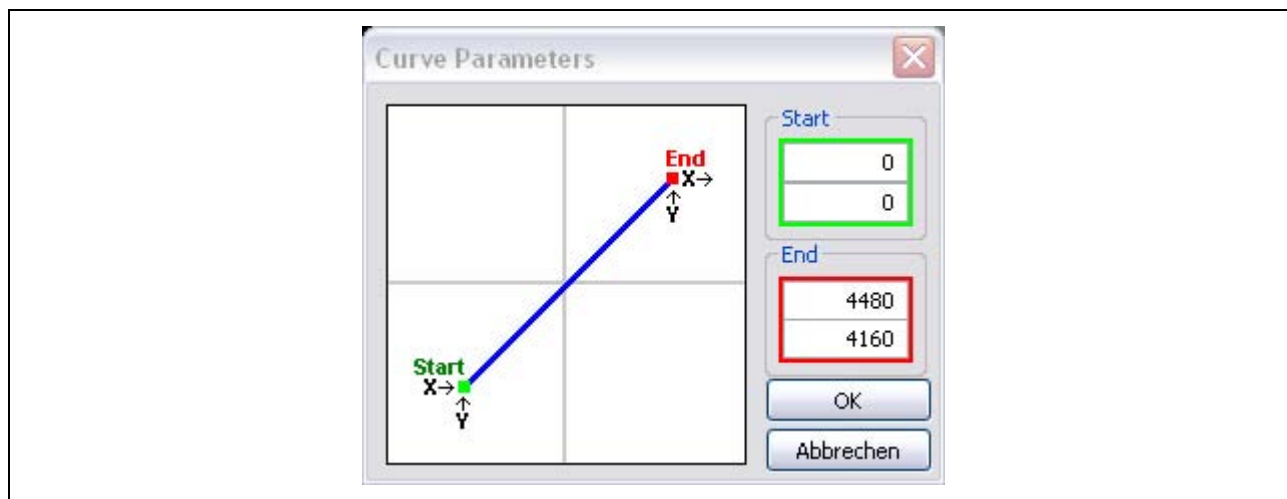

Fig. 7: The X and Y parameters of a line

You can enter the X and Y parameters of a line – start and end position – by hand for accurate positioning.

## 5.5.3 Parameter Circle

This dialog is used to position all circle parameters like radius, sector, starting point and center.

If a circle object is inserted, only a 90° segment with defined start, center and end point is created.

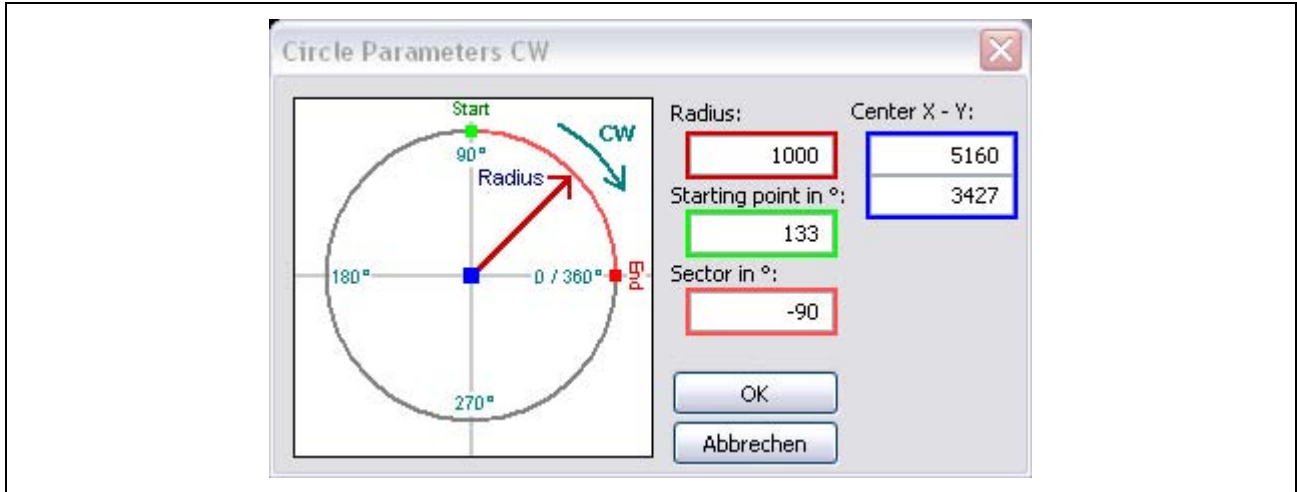



Fig. 8: Setting of all circle parameters

Shift the circle by:

- Click on the middle marker. Notice that all previous and followed circles are moved, which are directly cohered.
- Insert a new center point.

Also you can specify the sector, the radius and the starting point.

## 5.5.4 Desktop Functions

	<p>The zoom function changes the scale and the position of the desktop. The range of the desktop can be increased by click and drag.</p> <p>A larger scale can be specified in the <b>text field divisor</b>.</p> <p>The <b>Center View</b> button centers the zero line of the drawing area.</p>
	<p>Move the desktop by mouse click and drag. This is useful, if the drawing figure is too large for the desktop.</p> <p>The <b>Center View</b> button centers the zero line.</p>



### 5.5.5 Example

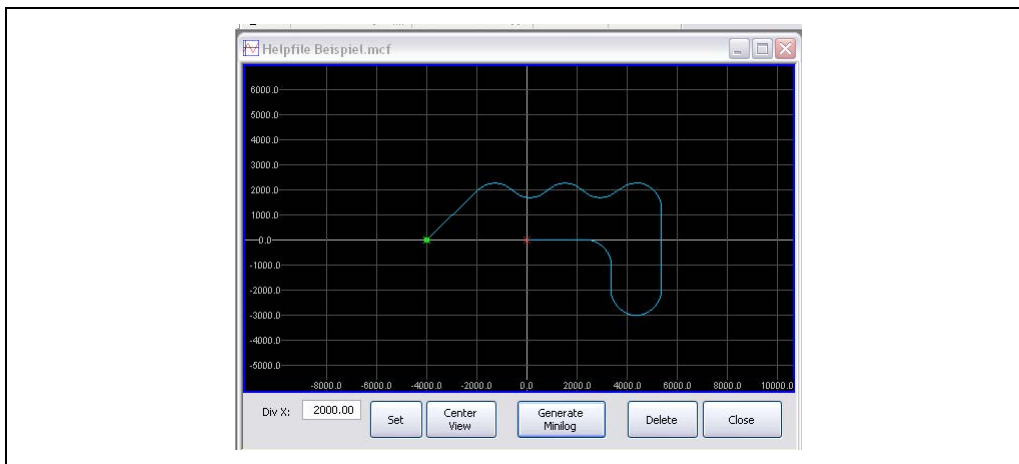

Fig. 9: A figure 'drawn' by the Motion Creator (way)

The marked segment shows the three marking points of a circle: start, end and center

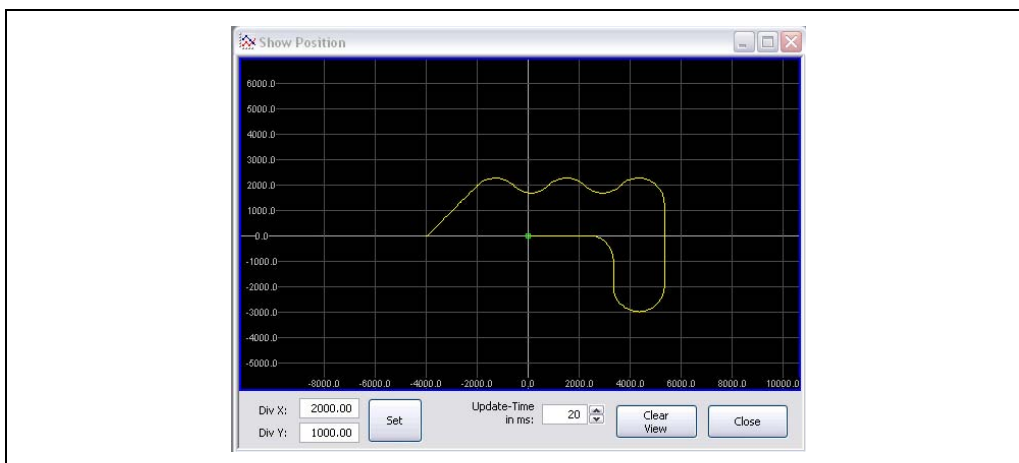

Fig. 10: Retraced figure in the Show Position (way)

Lnr.	Program	Comment
1	IS	
2	XF20S-4000 YP20S0	
3	X2000 Y2000 H	
4	KR1000 KS13S KW-90 H	
5	KR1000 KS22S KW90 H	
6	KR1000 KS13S KW-90 H	
7	KR1000 KS22S KW90 H	
8	KR1000 KS13S KW-135 H	
9	X0 Y-3293 H	
10	KR1000 K50 KW-180 H	
11	X0 Y1000 H	
12	KR1000 K50 KW90 H	
13	X-2364 Y0 H	
14	IR	

Fig. 11: The generated MiniLog code

## 5.6 The *Transmission* Menu

---

In *Transmission* menu you will find all functions to communicate with a phytron stepper motor controller connected to your PC:

- Read out or send parameters, programs and registers
- Delete programs in the controller
- Send instructions directly to the controller
- Drive connected motors
- Test the PC's interface and
- Monitor controller's status

### **Remark:**

Every instruction in this menu can cause a timeout error. In this case, the instruction is cancelled by an error message.

Please refer to chapter 6 to debug.

### 5.6.1 Send

---

*Transmission / Send* opens a submenu with the items Program, Parameters, Registers and Megacard. Megacard is an additional memory of the controller IXE $\alpha$ .

#### **Send program**

*Transmission / Send / Program* transfers complete programs to the connected controller. If a program editor is open, this program will be selected. If no editor is open or no program editor is in the foreground, a dialog box is displayed with the existing programs.

MiniLog-Comm asks for the program you want to send and gives a selection list of all stored programs. Select the program by double click on the left mouse button. You will be asked if the program does already exist and you want to overwrite it. If you press 'yes', all programs on the controller are overwritten. This instruction can't be canceled.

#### **Important for controller MCC:**

MiniLog-Comm receives all programs and deletes the whole controller memory. After that, the programs still required, are remitted to the MCC.

Please avoid to power off the controller or to disconnect the cable during transmission.

Danger of data loss!

### Send parameter

**Transmission / Send / Parameter** overwrites the parameters of the connected controller. The selected parameter files in the parameter editor are transmitted.

### Send register

**Transmission / Send / Register** overwrites the registers of the connected controller. The selected register files in the register editor are transmitted.

During transmission a progress bar will inform you about the actual transmission status.

After a successful data transmission, the desktop shows the message

*All Programs/Parameters/Registers successfully received*, which is confirmed by .

### Send Megacard

**Transmission / Send / Megacard** transfers programs, parameters und registers to the additional memory ‚Megacard‘ of IXE $\alpha$ .

Please avoid to power off the controller or to disconnect the cable during transmission. Danger of data loss!

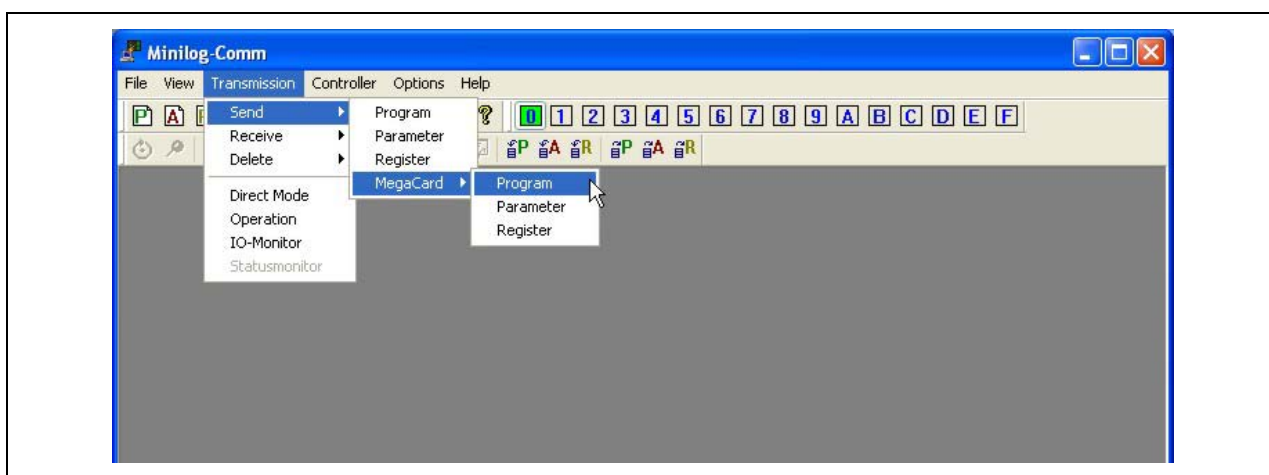

Fig. 12: Menu item 'Send Megacard Program'

## 5.6.2 Receive

**Transmission / Receive** opens a submenu with the items Program, Parameters, Registers and Megacard.

### **Transmission / Program**

MiniLog-Comm asks you, which program you want to read. Select a program of the controller programs list by click on the left mouse button. The selected programs are received then and displayed in MiniLog-Comm.

Please note that the programs aren't saved at that moment. MiniLog-Comm will ask to save them.

### **Transmission / Parameter**

**Transmission / Receive / Parameter** reads the parameter set out of the controller. Like in Transmission / Program: the parameters are displayed in the editor and can be saved afterwards.

### **Transmission / Register**

Like in Transmission / Receive / Parameter: the received register set are displayed in the editor and can be saved afterwards.

**Transmission / Megacard** reads the programs, parameter set and register set out of the IXEα's 'Megacard'.

A successful transmission of data is messaged on screen, which is acknowledged by

**OK**

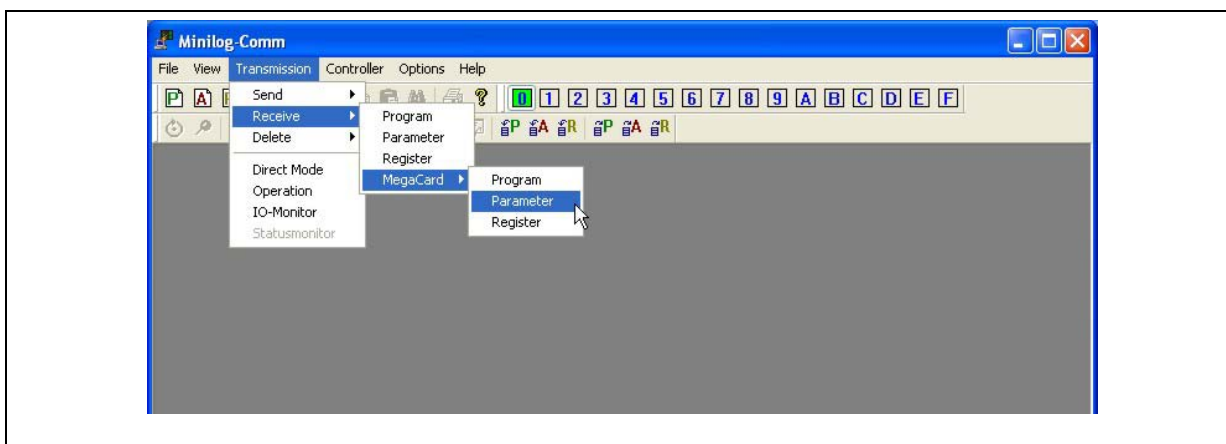

Fig. 13: Menu item 'Receive Megacard Program'

### 5.6.3 Delete

---

**Transmission / Delete** opens a submenu with the items Program and Registers.

#### Delete program

**Transmission / Delete / Program** deletes single programs in the connected controller. MiniLog-Comm shows a selection list with all programs in the controller memory.

Before the program is really deleted, MiniLog-Comm requires . The program is aborted with .

#### Important for controller MCC:

MiniLog-Comm receives all programs and deletes the whole controller memory. The programs still required are transmitted to the MCC again. Please avoid to power off the controller or to disconnect the cable during transmission. Danger of data loss!

#### Delete registers

**Transmission / Delete / Registers** sets all registers in the controller to zero. MiniLog-Comm asks for acknowledge before deletion.

#### Delete Megacard

**Transmission / Delete / Megacard** deletes programs, parameter set and register set or all files on the ‚Megacard‘ of controller IXE $\alpha$ .

**Attention:** ‚All‘ will take about 4 minutes!



Deleted programs or registers can't be recovered!

## 5.6.4 Direct Mode

**Transmission / Direct Mode** opens a dialog box which allows to send instructions directly to the stepper motor controller. MiniLog-Comm automatically generates the complete protocol.

Select first the input box to send a instruction to the controller. Now enter the MINILOG instruction, e.g. *XP14R*, which means: *read parameter 14 from axis X*, see Fig. 14:

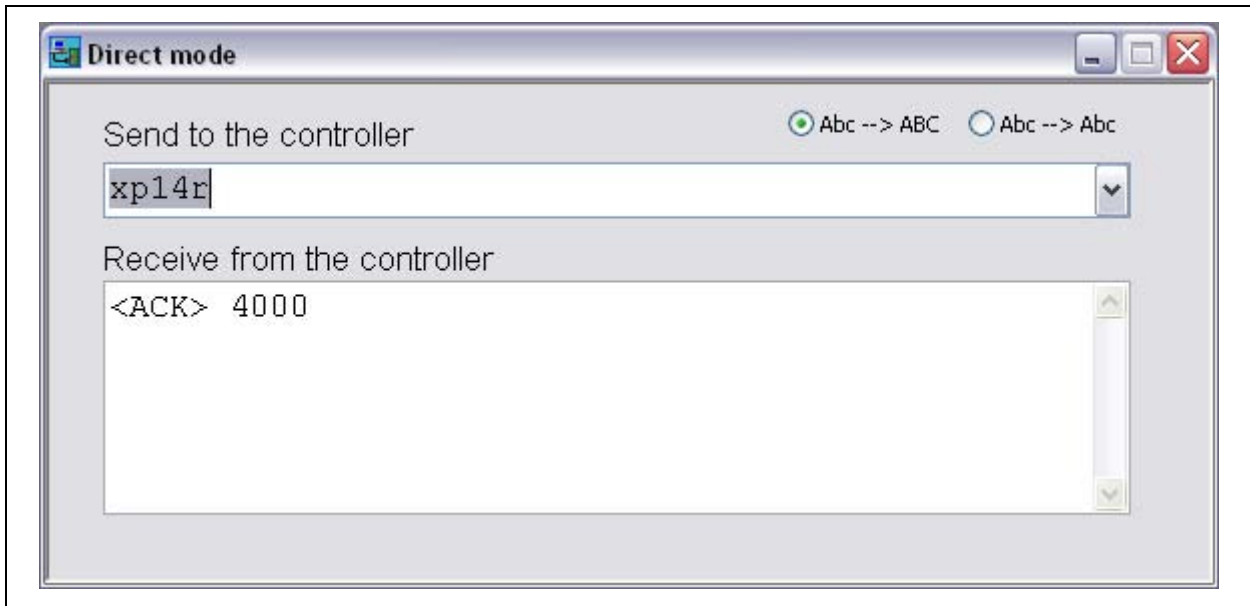

Fig. 14: Direct mode

The instruction is sent to the controller by pressing the **[ENTER]**-key.

The controller answer is shown in the response box, e.g. `<ACK> 4000`: the value of the parameter 5 of axis X is 4000.

A history list of used instructions can be opened by the DropDown key **[9]**.

### Remark:

Phyton controller's answer a `<NAK>` if an invalid instruction is used.

Nearly all MiniLog instructions can be written without consideration of the capital and small letters. The button `abc --> ABC` shifts the instruction.

### Important:

In case of or-logic operations (e. g. `Ev011`) and `d0` or `d1` display instructions click on button `Abc --> Abc` to keep the capital and small letters.

## 5.6.5 Operation

**Transmission / Operation** opens the window to move the motor directly by mouse click:

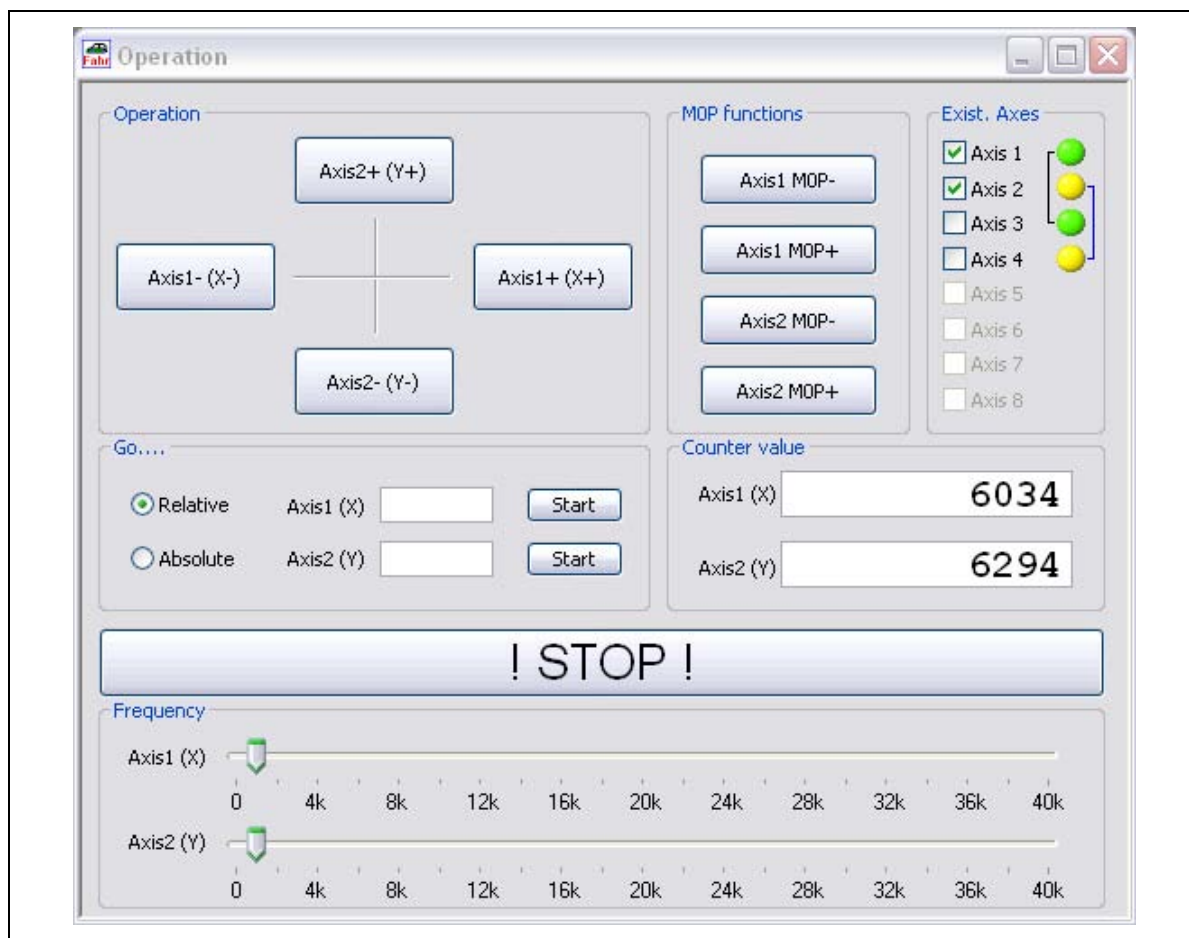

Fig. 15: Operation

Simply click on **Axis1-** to **Axis2+**. Direction + means clockwise movement, seen onto the motor axis from outside.

Drive instructions for both axes can be entered in **Go.....**

The symbol + or – before the entered number of steps defines the direction.

**Go Relative:** move from the actual position by x-counter values.

**Go Absolute:** the input counter value is referred to the zero point.

The instruction will be executed by click on **Start**. The movement is stopped by

**! STOP !** if required.

The drive frequencies of both motors can be changed by two slider controls at the bottom of the window. The frequency can be set from 1 to 40000 Hz in 100 Hz steps.

Each axis can be initialized by **Axis1 MOP-** to **Axis2 MOP+** and stopped by **! STOP !**.

The connected axes are displayed in **Exist. Axes**. Up to 2 axes can be selected to move.

In **Exist. Axes** you can implement a so-called "electrical wave" by the „LEDS“ among the existing axes selection. This means that two or more axes can be driven quasi parallel by clicking on **Axis Z +/-** or by an input of a range.

In fig.15 you can see the link of axes 1 with 3 and 2 with 4 as an example. Naturally three and more axes can be interconnected with one another, too.

## Function:

First, the axes which are to run with one another must be selected by clicking on the respective LEDs of the axes. Simple click marks green, double click yellow.

All green and all yellow axes drive together, i.e. by clicking on **Axis1+** the axes drive into positive direction.

By clicking on **Axis 4+** the axes 3 and 4 drive into positive direction.

By clicking on the LEDs again the allocation is canceled, the LEDs now are grey.

## 5.6.6 IO-Monitor

**Transmission / IO Monitor** tests the inputs and outputs. IO-Monitor differs between the controllers MCC and OMC/TMC:

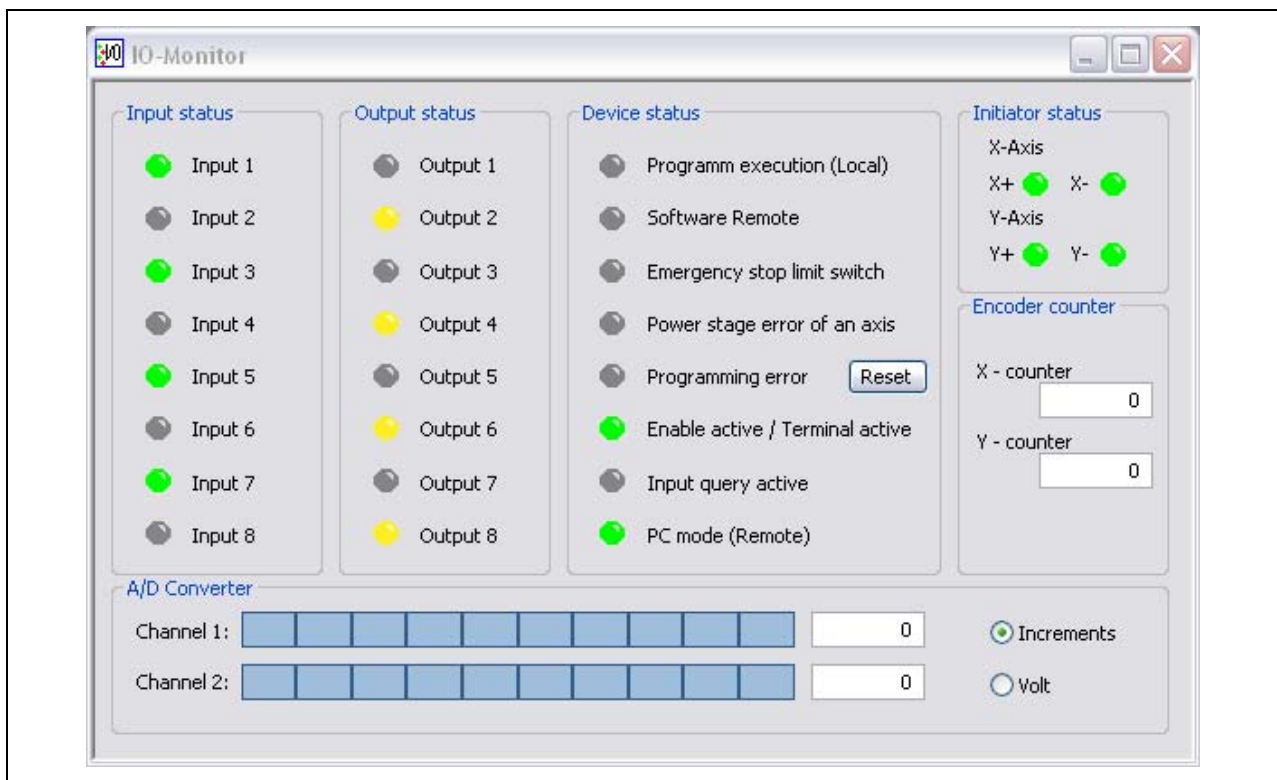

Fig. 16: IO-Monitor for MCC



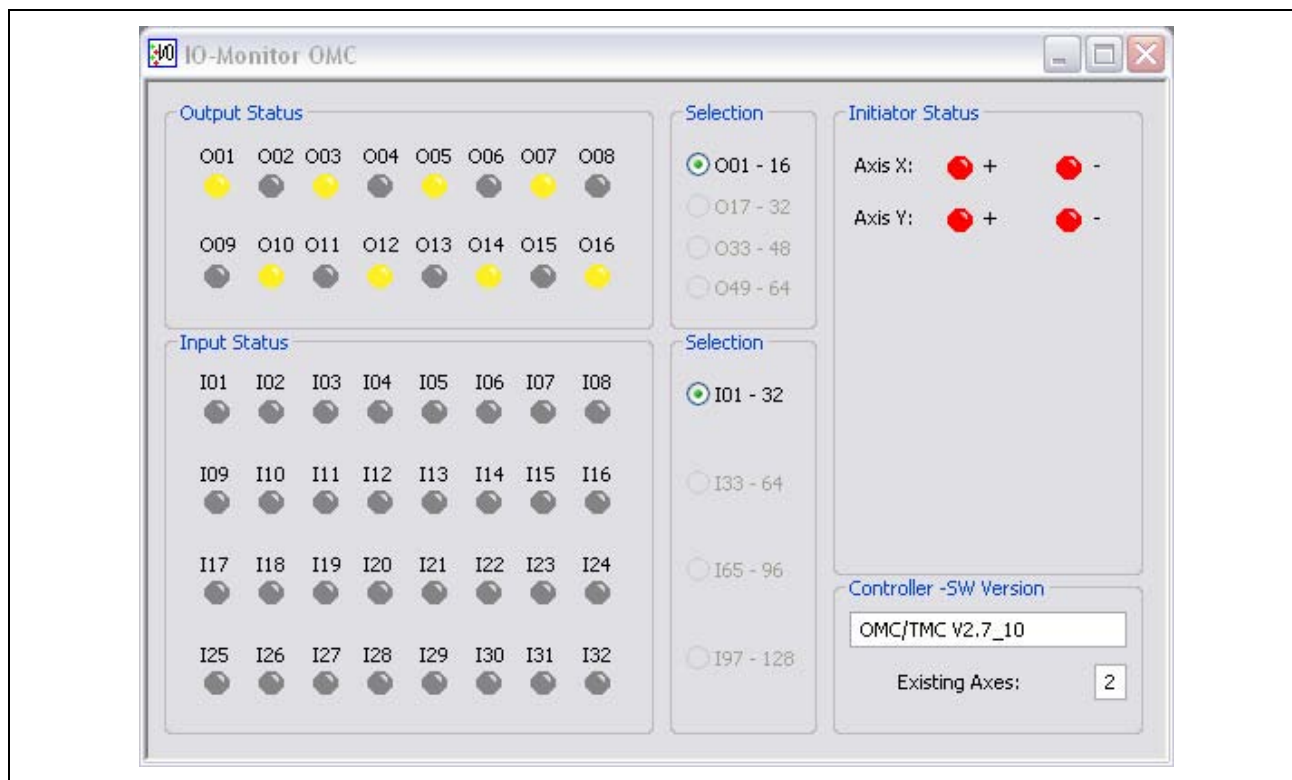

Fig. 17: IO-Monitor for OMC/TMC and IXE $\alpha$

**Input status** shows the controller's inputs:

LED green	Input activated
LED grey	Input deactivated

**Output status** shows the energized controller's outputs:

LED yellow	Output energized
LED grey	Output reset

The output state can be changed by click on one of the output LED.

**Device status** shows the controller's state:

- **Program execution (Local):** The controller executes a saved program. Either the controller is in Local mode or the program is started by an interface instruction.
- **Software Remote:** The controller has been set to the Remote mode by the instruction "IFR". The controller should be changed by the instruction "IFR" to operate the program start by the Remote/Local switch.

- **Emergency stop limit switch of an axis:** The limit switch of an axis is activated. You can get more information about activated limit switches in the IO-Monitor menu (Initiator status) (see chap. 5.6.7).
- **Power stage error of an axis:** The power stage of an axis has got an error, which can be e.g. over temperature, phase short circuit, under or over voltage.
- **Programming error:** An entered instruction was inoperative. The error can be reset by click on **Reset**.
- **Enable active (Power stage activated):** The controller's Enable input is wired, the power stages are activated.
- **Input query active:** The controller is in program flow and waits for an input. Instruction in program e.g.: E01S
- **PC mode(Remote):** The controller is in PC mode (switch setting Remote). The controller can be in PC mode at the same time and anyway, the status 'Program execution' can be set. In this case the program has been started by the interface.

**Initiator status** shows the state on the controller's limit switch inputs:

LED green	Initiator is not activated
LED red	Initiator is activated

**Encoder counter** shows the parameter 22 (count parameter of the encoder input).

**A/D Converter** displays the state of the controller's A/D converter inputs. The display can be changed between increments (0 –1023, 10Bit A/D converter) or Volt (the voltage of the A/D converter input).

**Selection** selects an approximate range of the inputs or outputs, which depends on the number of connected device addresses.

**Controller software version** shows the software version of the controller.

**Existing Axes** displays the number of axes connected to the controller.

### 5.6.7 Status Monitor (for OMC/TMC and MCC)

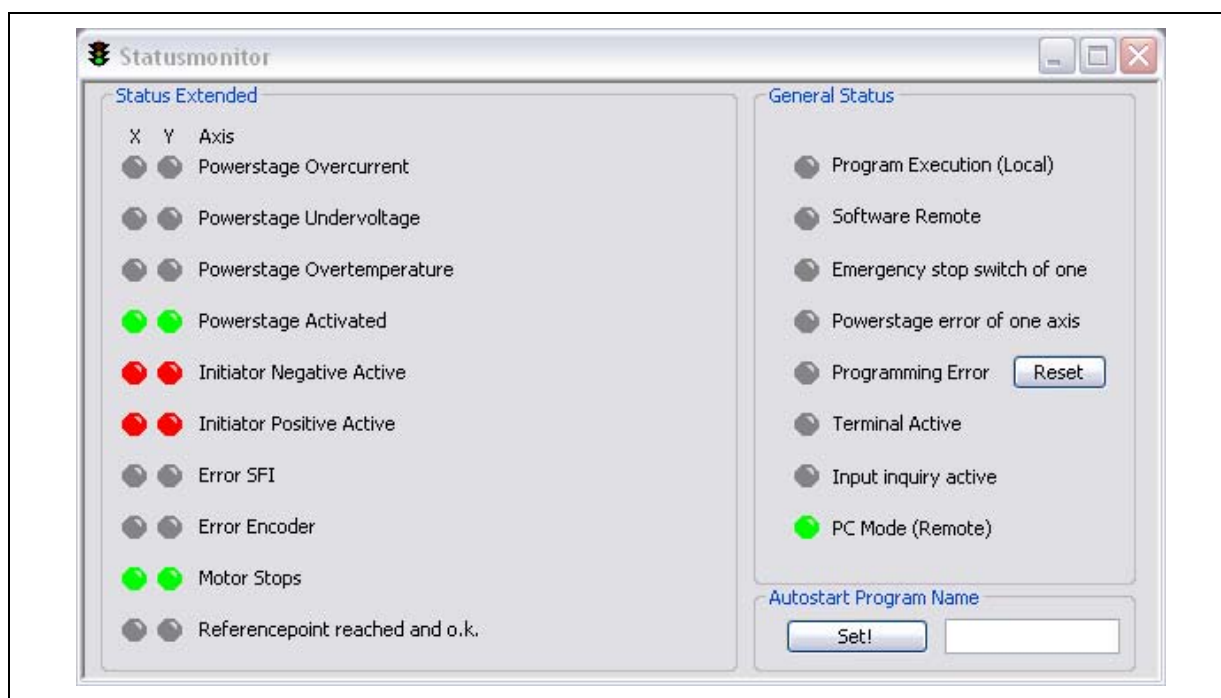

Fig. 18: Status monitor

**General Status** describes the general controller states. **Advanced Status** displays other controller states of the corresponding axis (axis 1 to 8).

**Auto start program name** shows the program name, which starts automatically after change-over the Local/Remote switch. The program name is stored in auto start of the controller by **Set!**.

Colour	State of the inputs	Initiator status
●	not active or not available	Initiator not available
●	active or OK	Initiator free
●	-----	Initiator activated

**Remark:** Only these I/O groups, which are supplied, are detected by MiniLog-Comm!

## 5.6.8 Show Position

**Transmission / Show Position** opens a window where the current X-Y position of the figure (yellow line) is displayed:

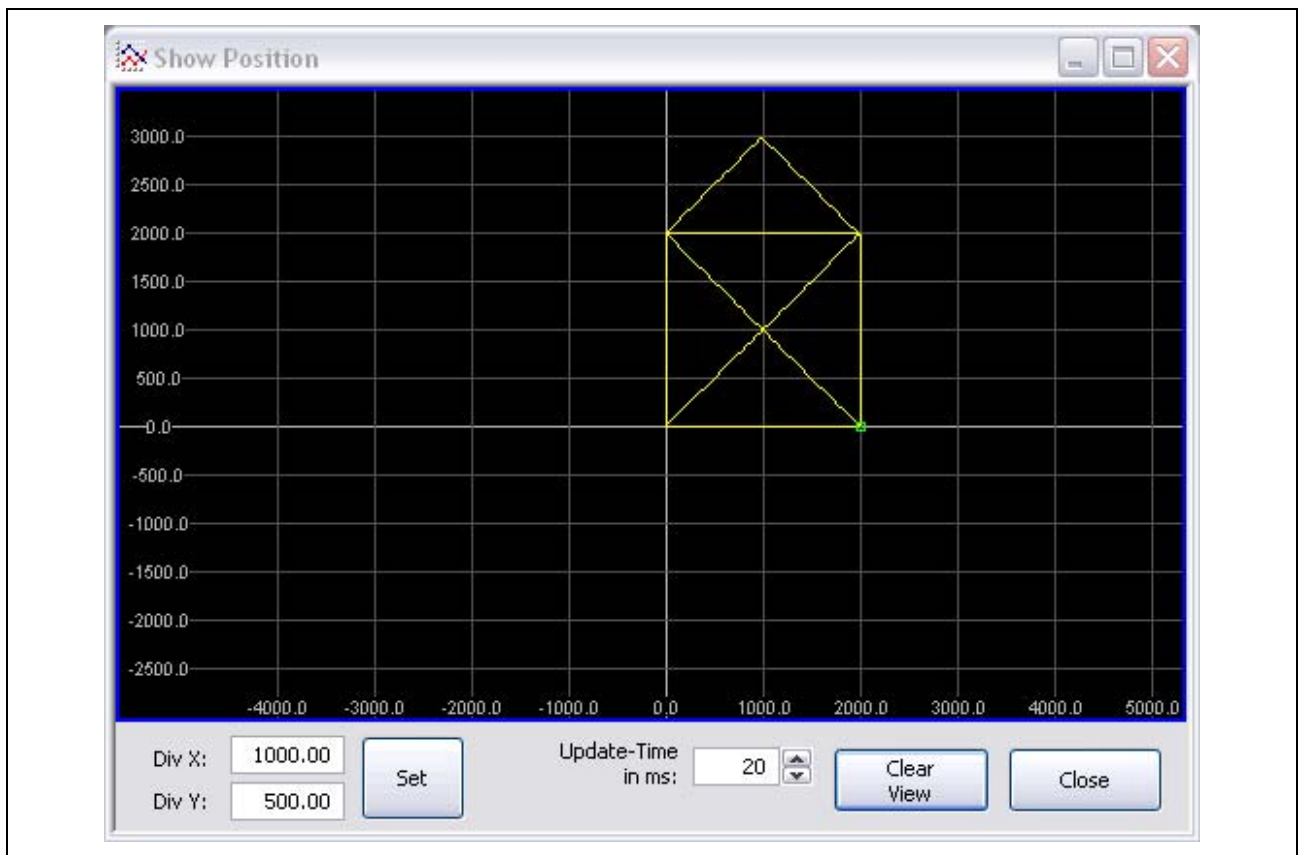
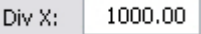







Fig. 19: Show Position

**Function of the buttons:**

	<p>The X axis is divided into grid points with the specified value.</p>
	<p>Usually the divisor of the Y axis is computed as <math>\frac{1}{2} X</math> (see also Fig.19). Other conversion factors can also be specified by hand.</p>
	<p>The changes entered at divisor X are accepted and shown.</p>
	<p>Indicates the period the position is read in. The smaller the update-time the more detailed is the screen display.</p>
	<p>Deletes the screen display!</p>
	<p>The window is closed. If the graphic has been changed, you are asked for saving.</p>

## 5.7 The *Controller* Menu

### 5.7.1 Autostart Program

**Controller/Autostart Program** displays a list of programs stored in the controller. A program for the auto start register is selected by mouse click, which is started automatically in the LOCAL mode.

### 5.7.2 Search Controller

**Search Controller** searches the connected controller. The COM port which is set in the interface parameters is scanned in all addresses and adjustable baud rates. If a controller is found, the COM port, baud rate and version are displayed. If no controller is found, an error message follows. A progress bar informs about the search progress. The search can be interrupted by **Cancel**.

### 5.7.3 Current Settings (for OMC/TMC and MCC)

**Controller/Current Settings** sets some axis parameter values like stop current, run current and boost current of the selected axis.

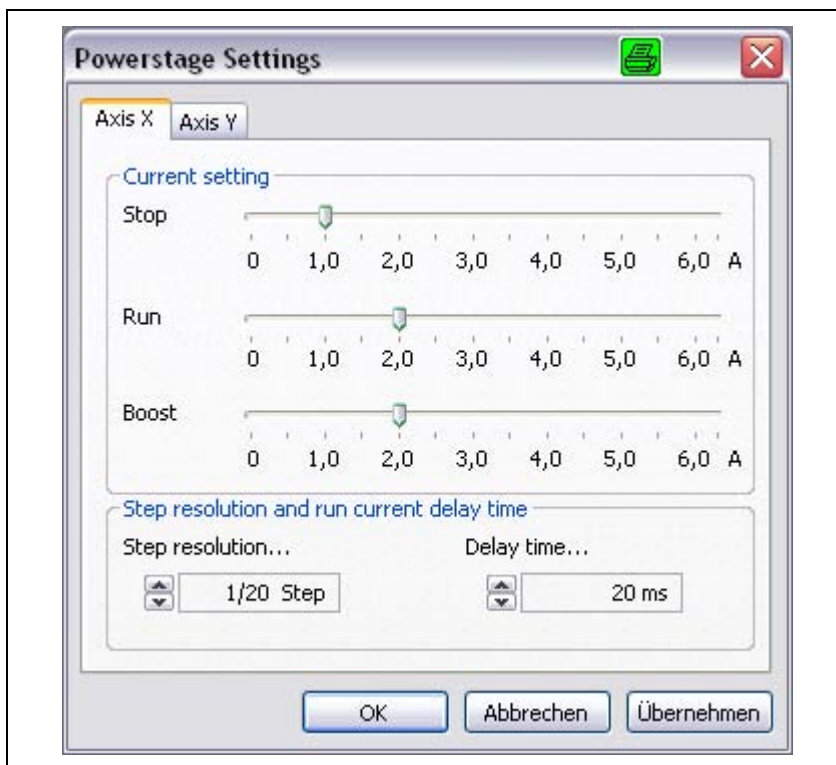

Fig. 20: Power stage settings

**Axis X, Axis Y** changes between the two existing axes.

**Step resolution** and **run current delay time** can be selected in the Drop-down bar.

The dialog accesses the controller parameters. Changes can be received and saved by a parameter editor.

**Important:** Please check the motor plate for the current setting!

### 5.7.4 Reset (for OMC/TMC and MCC)

**Reset** resets the controller.

**Attention:** This menu item has the same function as Reset push-button on the controller. Running programs are interrupted and all outputs are reset.

If the controller is in Local mode, the program starts in line 1, which is entered in the auto start register.

### 5.7.5 Firmware Information

This submenu reads the firmware version of the controller and displays it.





### 5.7.6 Firmware Update (for OMC/TMC and MCC)

This dialog is only available, if no other window is open. The **Controller/ Firmware Update** menu makes it possible to update the firmware in the controller.

**Important:** There are different firmware files for the controllers OMC/TMC or MCC. The update of a wrong file makes the controller inoperable! Please check the right selected files before the update.

**Important:** Save all controller files like programs, parameters and registers before the update.

The **Control lamp** shows the state of update:

Control lamp	Display	Status
	???	no action
	deleted	Firmware or system deleted
	OK!	Successful firmware update
	Error	Error during update



The update of a wrong file makes the controller inoperable!

## Firmware Update MCC

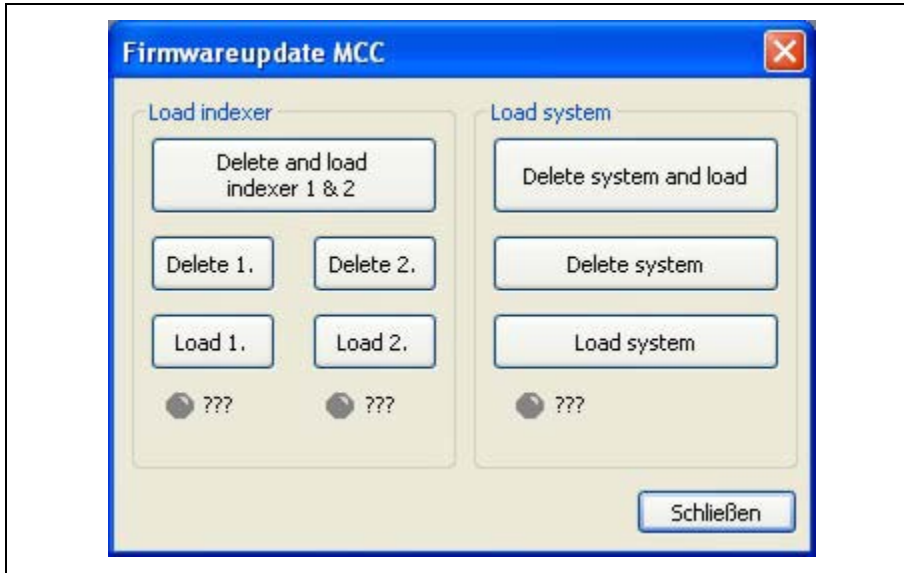

Fig. 21: *Firmware update MCC* menu

### **Load Indexer:**

The controller MCC offers the possibility to update both the indexer and the system of the controller. There are two different files: IndexerVX.hex for indexer and MCC\_System\_VX.hex for system files.

**Delete and load  
indexer 1&2**

Click on **Delete and load indexer 1&2** to load the indexer firmware. A dialog is opened to select the file for loading. Select the IndexerVX.hex and acknowledge by **OK**. First, the software on the controller is deleted. After that, you are asked to press the Reset push-button on the controller.

**Important:** Acknowledge this message only after the reset push-button has been pressed! After that the upload of the new firmware starts. The update takes a few minutes, a progress bar informs about the actual state.

Click on **Delete 1.** and on **Load 1.** to delete and update the indexer firmware for axis 1, click on **Delete 2.** and on **Load 2.** to delete and update for axis 2.



## Firmware Update OMC/TMC

The BIOS of the controller OMC/TMC can be updated.

**Important:** After the update the system is deleted on the controller. Please make sure that a system file exists for the controller which has to be loaded after the BIOS update.

**Important:** The BIOS file can only be loaded via interface X9 on the controller.

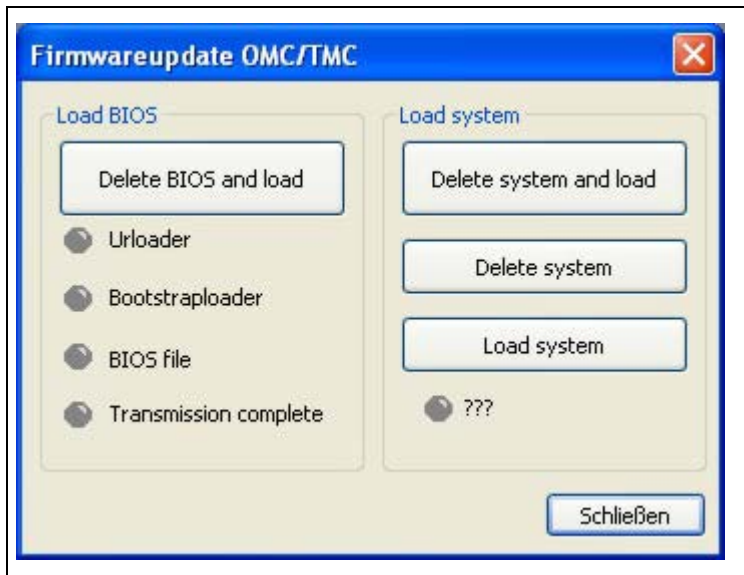

Fig. 22: Firmware update OMC/TMC menu

Before the new BIOS file can be loaded to the controller, the controller processor **must** be switched to the **Loader Mode**.

**The following order** should be observed:

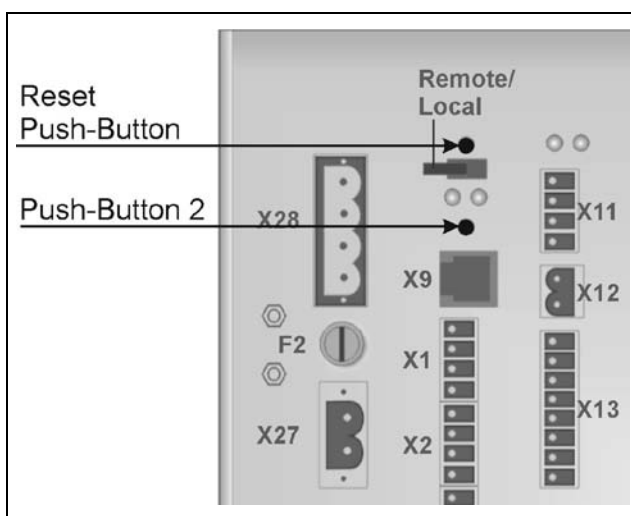

Fig. 23: The OMC/TMC push-buttons

- First press **and** keep push-button 2 above the interface X9.
- Then press and release the reset push-button (above the R/L switch).
- Only now release push-button 2.
- Afterwards press **Delete BIOS and load**. The dialog for file selection opens.
- Select the new BIOS file to transmit to the controller.  
**Important:** The update of a wrong firmware file makes the controller inoperable! However, the right BIOS file can be reloaded anytime.
- The control lamps show the update progress: ‚Urloader‘, ‚Bootstraploader‘, ‚BIOS file‘, ‚Transmission complete‘ shine one after another. A progress bar informs about the BIOS file transmission. If all control lamps shine green, the update is successfully finished. If one of the control lamps shines red, the upload has failed. In this case repeat the steps above after a file and interface cable check.
- Continue the update after a successful BIOS update by **Load System**.

**Load System** allows to delete and load the system software of the controller. The system update procedure is like the indexer or BIOS update. After click on

**Delete system and load** the firmware file can be selected. Then the controller upload begins. A progress bar informs about the actual state.



**Important:** Please avoid to power off the controller or to disconnect the cable during the controller update. Danger of data loss!

## 5.7.7 Password

---

In this submenu a password protection for the controller access can be set:

- **Send PW**: Enable controller bei initialization without a password input or with the password already definded
- Select program, parameter or register by ▼ and **Set Enable**.
- Set/change password by password input and clicking on **Change PW**.
- **Delete PW**: Delete the password.

			
Control lamp	Controller <b>disabled</b>	Access enabled with correct password	Access refused, because no or a wrong password was entered.

The password protection is activated by a RESET or a controller's switching on/off.



Fig. 24: Initial state





Fig. 25: Password enabled

## 5.8 The *Execute* Menu (for OMC/TMC and MCC)





The **Execute** menu helps for tests of the controller's program flow step by step.

The controller's program is started by **Start**  and runs until it is stopped by **Stop** .

The program begins at the beginning by **Start** .

The controller's program runs instruction by instruction by **Single step** . The controller's program can be stopped during run by **Pause**  and continues running by **Start** at the stop position.

The program run is finished by **Stop** .

	Start the single step mode for controller's program
	Start the controller's program
	Interrupt the controller's program
	Stop the controller's program
	Monitoring: Query of variables in a controller's program

## Debug (Read Variables)

MiniLog variables are monitored and displayed during program run by **Monitoring** .

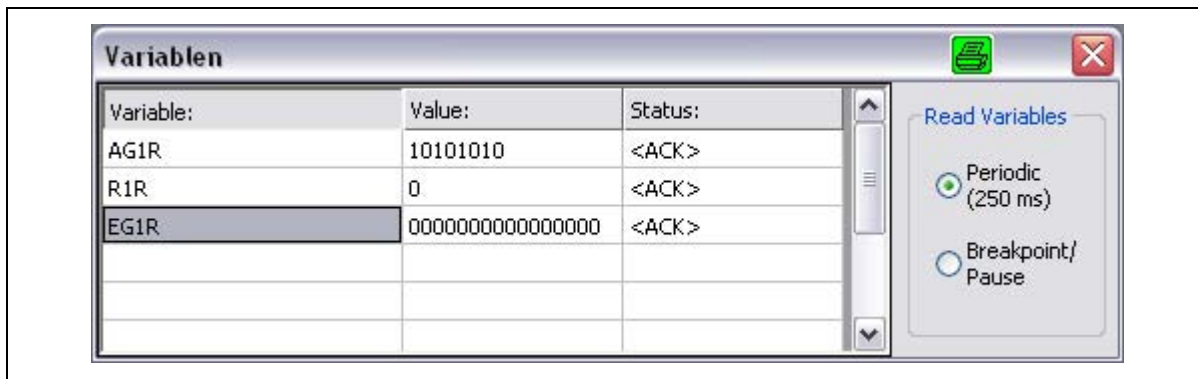

Fig. 26: Defined variables for program flow

**Periodic (250 ms):** The defined variables are read every 250 ms.

**Breakpoint/Pause:** The variables are read out at the breakpoints or in the single step mode.

## Break point setting

10 break points can be set to interrupt the controller's program in defined lines. This break point is set by click on the program line number with the mouse. The line number is marked red.

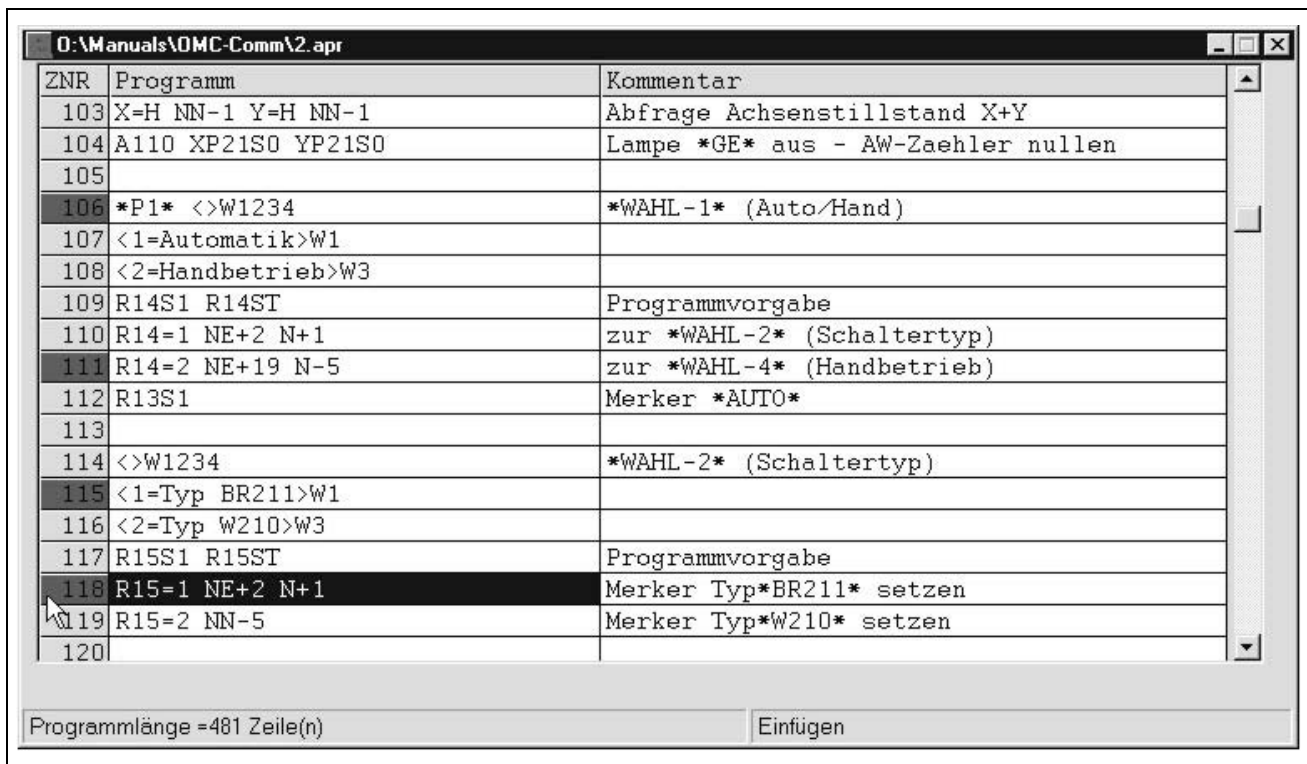

Fig. 27: Break points in lines 106, 111, 115, 118 (only available in German)

## 5.9 The *Options* Menu

**Important:** The *Options* menu is only available, if no window is open.

### 5.9.1 Interface Parameters

#### RS232 / RS485

Several interface parameters can be set in this submenu.

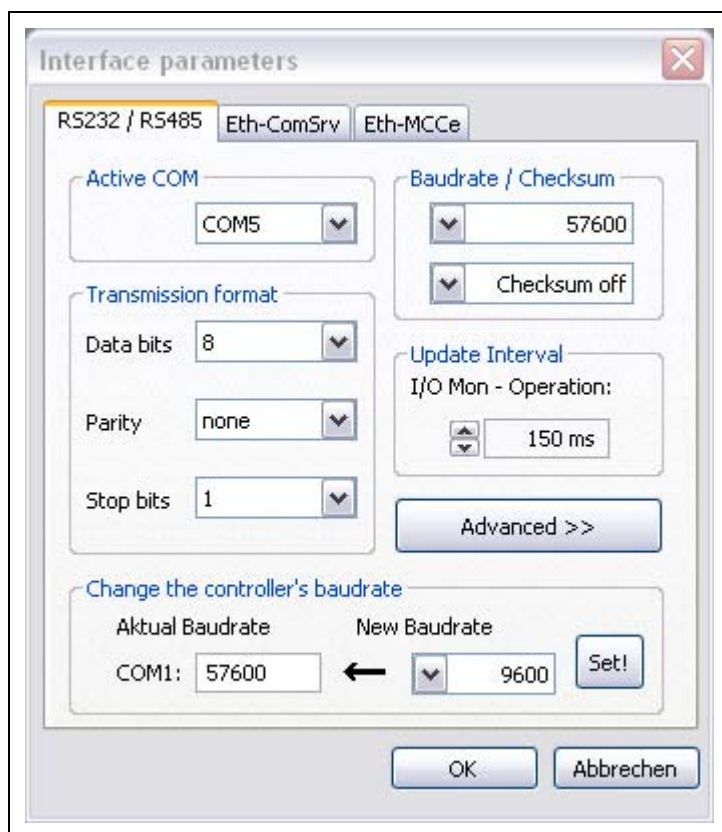

Fig. 28: Interface parameter settings

#### Active COM

The interface is set the controller is connected to. MiniLog-Comm searches automatically for available PC interfaces (up to 256). Installed USB --> RS converter interfaces are also found und displayed.

#### Baud rate / Checksum

The **Baud rate** (data volume per second in KBits) can be selected by click the drop down arrow of the **Baud rate** box (values from 9600 to 115200). The value must be compatible to the controller's baud rate.

**Remark:** We recommend to search the controller via the function **Search controller**, if you don't know the preset baud rate of the controller.

**Checksum:** (for OMC/TMC and MCC controllers):

Checksum ON: the transmission telegram is monitored with checksum by the controller.

Checksum OFF: the transmission telegram is sent without checksum by the controller.

## Transmission format

The transmission format of the interface is set.

**Important:** These settings must not be changed! They are designed for additional controllers.

## Update interval

**Update interval** is set for the IO-Monitor, Operation mode and all other menus, which poll cyclic data via the interface. Lower baud rates enable slow intervals. If many dialogs are open at the same time, we recommend increasing this time.

The changes are accepted by **OK** and the interface is initialized with new parameters.

**Cancel** aborts without changes.

**Advanced >>** opens the advanced interface dialog. (Fig. 28)

## Change of the Controller's Baud rate

The baud rate of the controller can be changed in **Advanced >>**. The actual baud rate is read in **Actual Baud rate**.

In **New Baud rate** a new baud rate is selected for the controller by Drop-Down. The new baud rate is set in the controller by click on **Set!** and the baud rate of the PC is set to the new baud rate. This function requires communication to the controller. Therefore, the baud rate and the COM port should be set correctly.

**Eth-ComSrv**

This submenu is useful for remote maintenance in the company network by connecting to the receiver with the receiver's IP address.

First, in **Options / Server** (see chap. 5.9.4) the receiver's IP address must be identified.

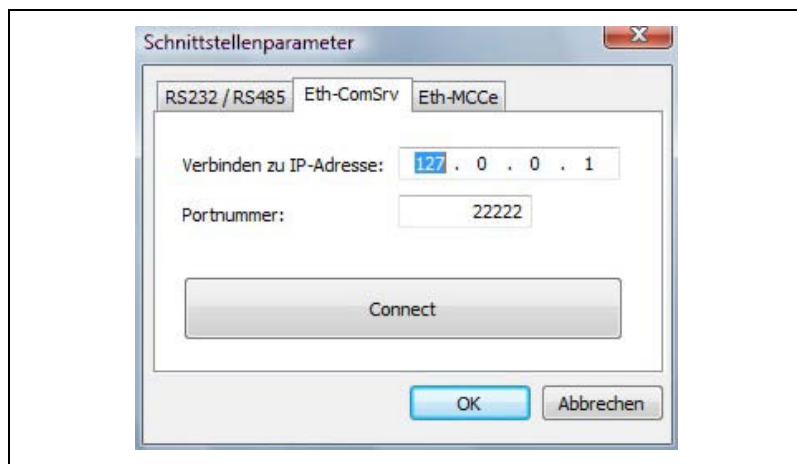

Fig. 29: Connection to the server in the company's network

**Connect**: Connection to the receiver's IP address. The port number is written in the controller's manual.

**OK**: The device is online.

## Eth-MCCe

A connection to a MCC controller via Ethernet interface:

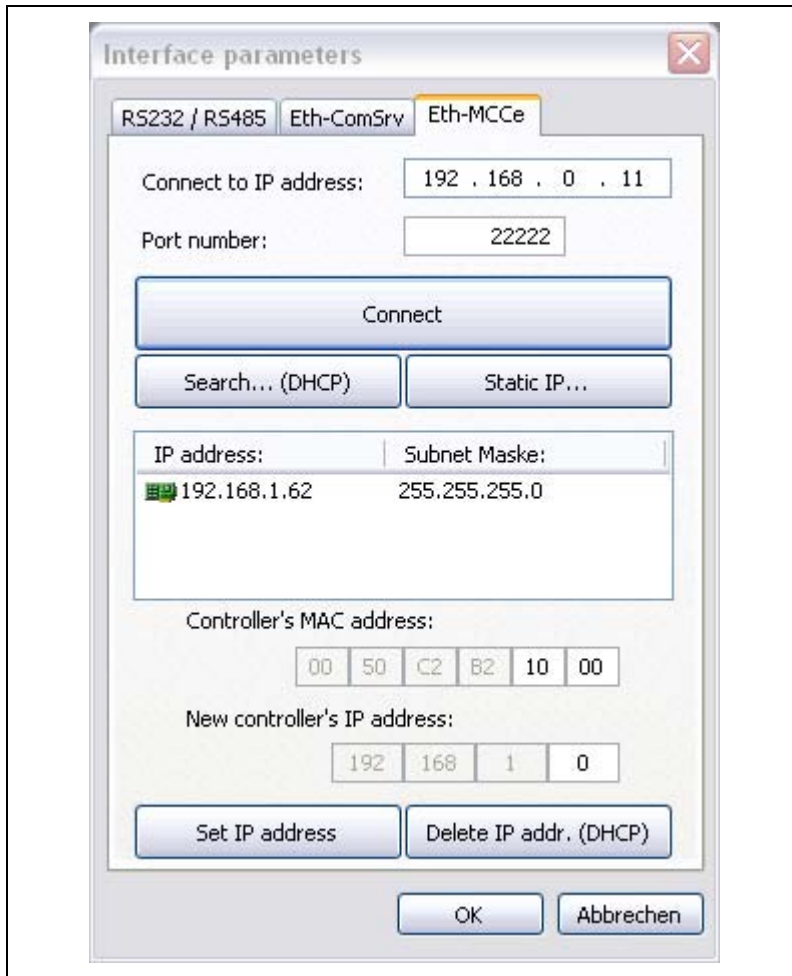

Fig. 30: Connection to the MCC controller

### i

The controller refers its IP address either dynamically over DHCP or in a static way.

**Search... (DHCP)**: The IP address of the controller is searched only in the same subnet. This function only, if the controller obtained a valid IP address over DHCP.

**Static IP...**: Installation of the controller's IP address by MAC- and IP address input.

**Set IP address...**: Allocate the input IP address.

- You'll find the controller's MAC address on its type plate. Enter the MAC address in the appropriate input field.



- If the PC is logged-in to more than one network interface card: Select that IP address from the displayed list to which network interface card the controller is connected.
- Enter a new IP address in the input field.
- Setting of the entered IP address by clicking on **Set IP address...**.

**Delete IP address (DHCP)**: Delete the IP address and reset the controller to the DHCP mode.

**Connect**: Connection to the controller via selected IP address. You'll find the port number in the controller's manual.

**OK**: The device is online, which is shown in the status bar line.

## 5.9.2 Controller Type

---

**Options / Controller type** selects the type of the connected controller. The MCC, OMC/TMC and IXE $\alpha$  (IXE Alpha) controller types are available. The MiniLog-Comm software is continually adapted to new phytron controller types, which are also programmed in MiniLog language.

## 5.9.3 Language

---

**Options / Language** selects the output of the program dialog in German or English.

## 5.9.4 Server

**Options / Server** integrates the controller into the customer's network by Ethernet. Thereby a data exchange is possible in form of TCP/IP network protocols between all devices in a local network.

The controller's data can be accessed by coworkers, who logged-on with the correct IP address, for telemaintenance.

How to do:

- PC-1 with connected controller: **Com Server** at **IP Address**: the IP address of PC-1 is read.
- The readiness for data receive is enabled by click on **Listen Port**. Keep the window open.



Fig. 31: Example: read data on PC-1

- Enter the IP address of PC-1 and the port number on PC-2 in **Interface parameters/Ethernet** at **Connect to IP address**. PC-1 and PC-2 are connected by click on **Connect**.

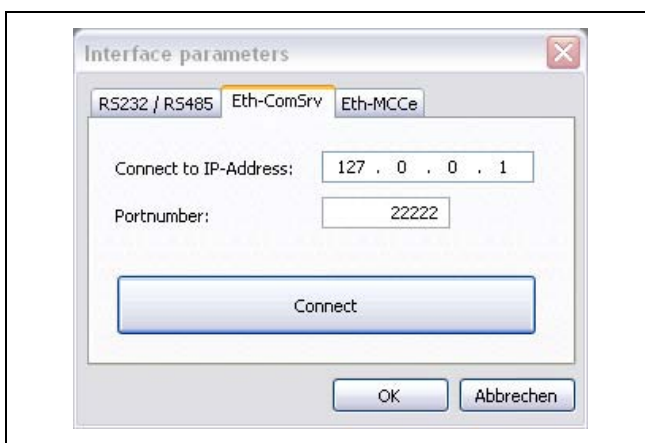

Fig. 32: Example: data enter from PC-1 to PC-2

- Then the PC-2 can set the controller by **Transmission/...** menus.

**Important:** The server (PC-1) must be connected to the controller! Danger of data loss!

## 5.10 The *Windows* Menu

**Windows** menu arranges optically the displayed axis windows. The directories of all files are listed after click on **Windows**. The active window is selected on screen by mouse click. The displayed open window is marked by ✓.

### 5.10.1 Cascading Windows

Several open axes files are arranged in a cascading mode by click on **Cascading**.

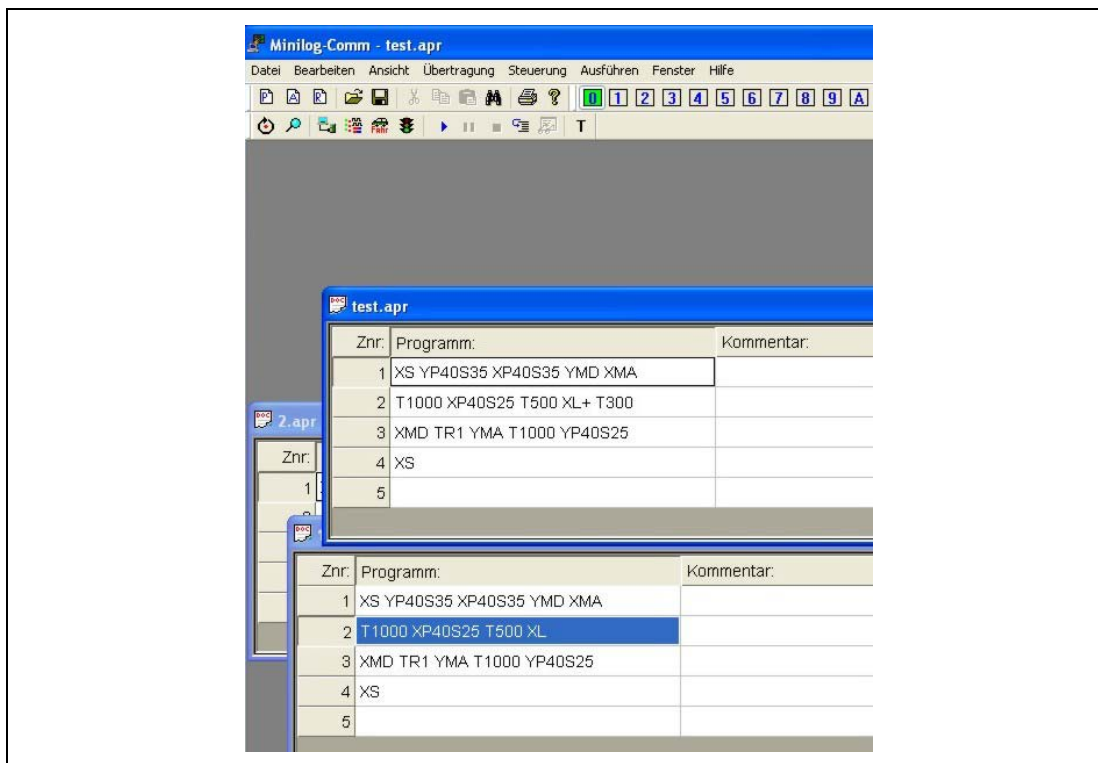

Fig. 33: Before

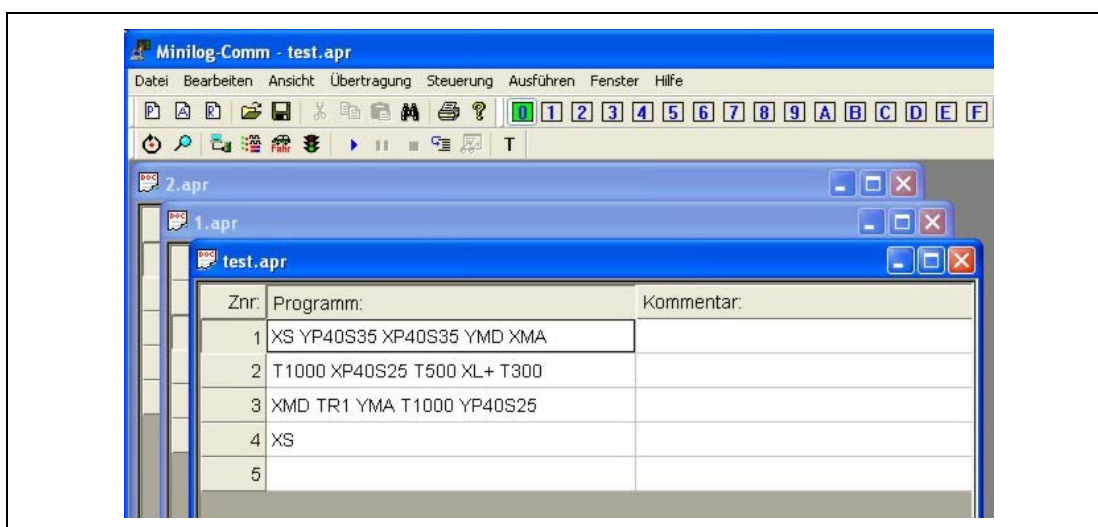

Fig. 34: Afterwards

## 5.10.2 Tile Windows

The open axes files are placed horizontally by click on **Tile Windows**:

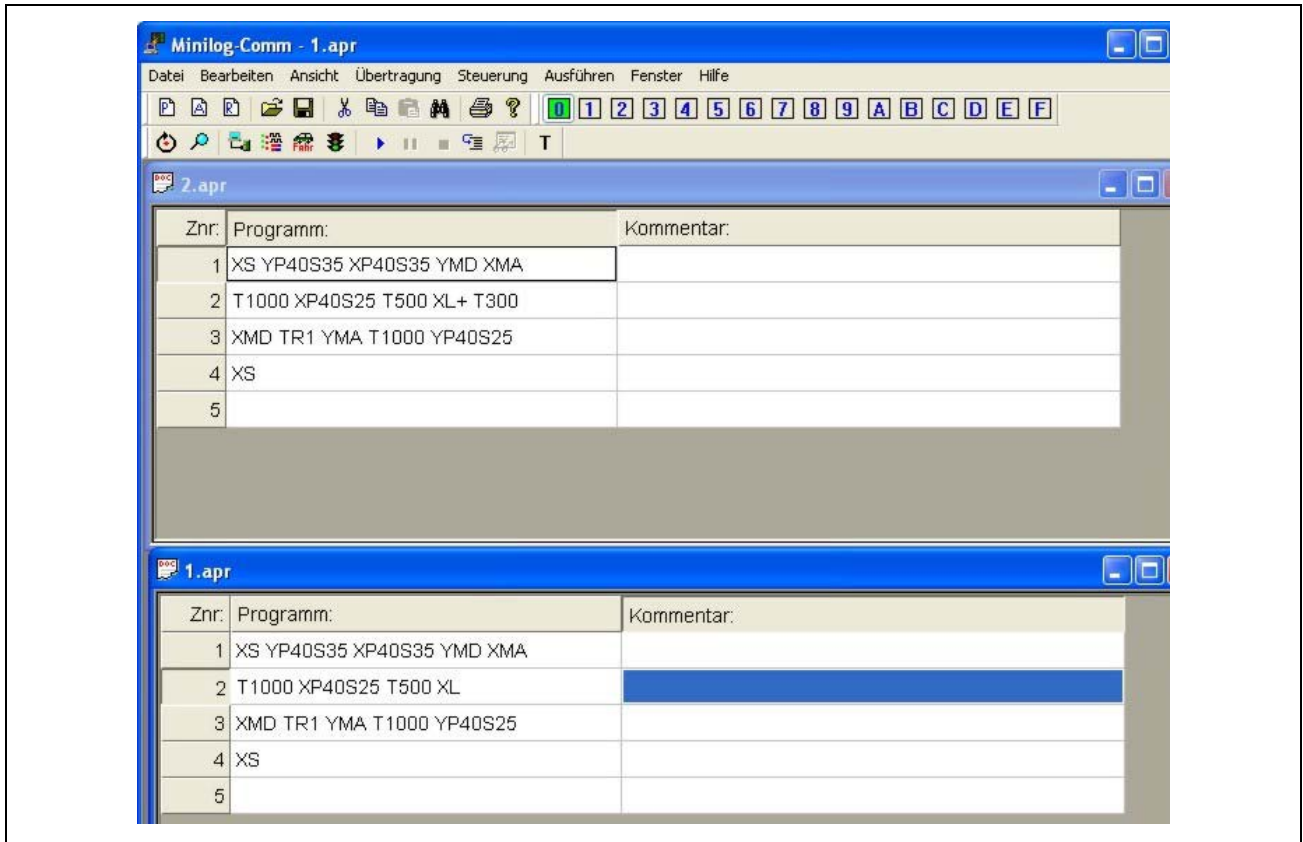

Fig. 35: Window: side by side

## 5.10.3 Place Symbols

The downsized program windows on the lower screen edge are placed in a row side by side.

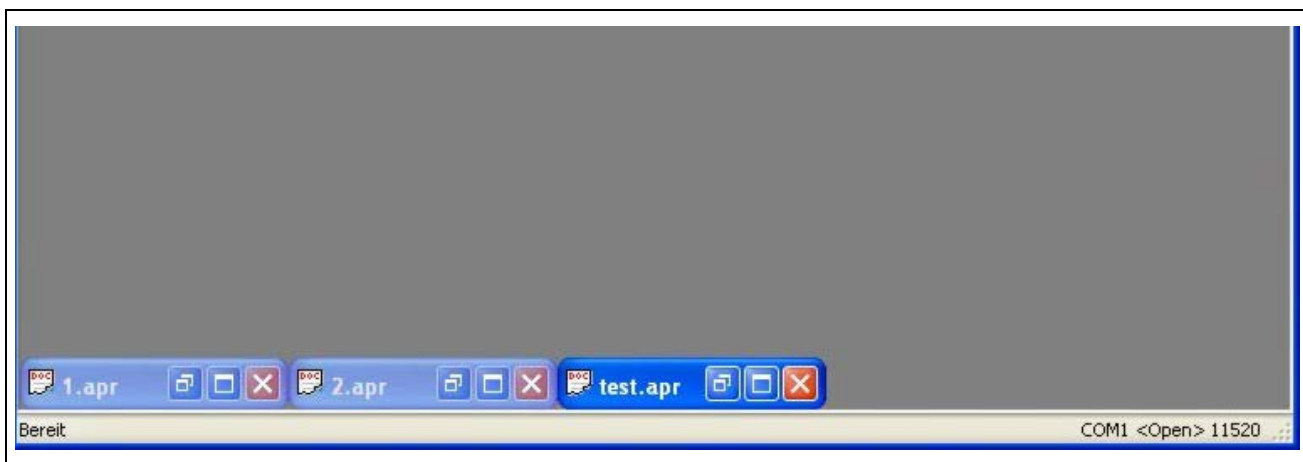

Fig. 36: Window: place symbols

---

## 5.10.4 Save/Load Position

---

The order of the open menu windows (only Direct mode, Operation, IO Monitor, Status monitor and Show position) is saved by click on **Save window position**.

With **Load window position** the saved order is displayed on the desktop.

## 5.11 The *Help* Menu

### 5.11.1 About MiniLog-Comm®

---

**Options / About MiniLog-Comm** gives important information about the program version of MiniLog-Comm, copyright and phytron's firm data (fig. 35).



Fig. 37: Information about MiniLog-Comm

### 5.11.2 Help

---

**Options / Help** menu opens the help function of MiniLog-Comm.

## 6 Error Messages

---

In this appendix you will find hints how to handle error messages of MiniLog-Comm. Messages are not contained in this appendix, which do not need any additional information.

### **Remark:**

Error messages related to problems with any peripheral device are very often caused by trivial facts like: device is not switched on, cables are missing, cable is defect, etc. Please check these items.

### **Interface Problems**

#### **An interface timeout has occurred**

Possible reasons for this problem may be:

- The cabling is wrong (RD and TD pins interchanged).
- The controller is not in the REMOTE operation mode (Switch Remote/Local).
- The cabling is defect or interrupted.
- The timeout time selected in MiniLog-Comm is too short.
- The interface parameters selected in MiniLog-Comm do not match the controller type used.
- No controller connected

#### **COM Interface already open**

Possible reason for this problem may be:

- The COM interface is already used by another program.

---

## 7 Copyright and Limitation of Warranty

---

The software MiniLog-Comm and any documentation delivered with it are protected by copyright law. The manual must not be copied, reproduced, put into machine readable form, neither complete or in parts, without the prior written permission of the Phytron GmbH.

MiniLog-Comm as a freeware product will only give you the right to make backup copies for personal use. However, the program must not be changed neither be sold.

### Limitation of warranty

The software MiniLog-Comm and its documentation have been made with great carefulness and have been reproduced under effective controlling measures. Nevertheless there might be mistakes.

We refer to our delivery and payment conditions, in particular to item VII liability and item IX software utilization.

You'll agree to our delivery and payment conditions, if you install, copy or use otherwise the software. If you disagree to these conditions you aren't authorized to install or use the software.

### Trade marks

In this manual several trade marks are used which are no longer explicitly marked as trade marks within the text. The lack of this signs may not be used to draw the conclusion that these products are free of rights of third parties. Some product names used herein are for instance

- Microsoft is a registered trade mark and WINDOWS is a trade mark of the Microsoft Corporation in the USA and other countries.
- MiniLog-Comm is a trade mark of the Phytron GmbH.

## 8 Index

---

### A

A/D converter 35  
Axes 6

### B

Baud rate 45, 46  
BIOS file 41, 42  
Break point 44

### C

Cabling 54  
Capital letter 30  
Cascading windows 51  
CD-ROM 8  
Checksum 46  
Circle 24  
Clockwise 21, 22  
COM interface 54  
COM Server 50  
Controller type 49  
Copyright 4, 53

### D

Debug 44  
Defect cabling 54  
Desktop 21  
DHCP 48  
Direct mode 30  
Divisor 18, 37  
Draw 21

### E

Edit 20  
Encoder 35  
Ethernet 48, 50

### F

Firmware 39, 40  
Font 21

### H

Help 53

### I

Indexer file 40  
Input 33, 36  
Installation program 8  
Interface parameter 45, 47  
Interface problems 54  
IO Monitor 32  
IP address 47, 48, 50

### L

Language 50  
Line 23  
Loader 41, 42

### M

MAC address 48  
Main features 6  
Megacard 26  
MiniLog code 25  
MiniLog-Generator 18, 37

### O

Object 22  
Operating system 7  
Operation 31  
Options 45, 49  
Output 33

### P

Password protection 42  
Program Editor 15  
Program version 53  
Push-button 41

### R

RAM 7  
Register 6  
Research 20

### S

Search 20  
Selection menu 11  
Send 26  
Setup.exe 8



Single step 44  
Software version 35  
State line 11  
System file 40, 41  
System requirements 7

**T**

Tile windows 52  
Transmission 21, 26  
Transmission format 46

**U**

Update 41, 46

USB driver 10

**V**

Variables 44

**W**

Windows 51  
Working environment 11

**Z**

Zoom 21





**Phytron GmbH • Industriestraße 12 • 82194 Gröbenzell, Germany**  
Tel. +49(0)8142/503-0 • Fax +49(0)8142/503-190 • E-Mail [info@phytron.de](mailto:info@phytron.de) • [www.phytron.de](http://www.phytron.de)

**Phytron, Inc. • 600 Blair Park Road Suite 220 • Williston, VT 05495 USA**  
Tel. +1-802-872-1600 • Fax +1-802-872-0311 • Email [info@phytron.com](mailto:info@phytron.com) • [www.phytron.com](http://www.phytron.com)