

STF-R/C/D/IP

Stepper Motor Drive Hardware Manual



Contents

1	Introduction.....	4
1.1	Features.....	4
1.2	Block Diagram.....	5
1.3	Safety Instructions.....	8
2	Getting Started	9
2.1	Installing Software.....	10
2.2	Connecting Communication (-R model).....	11
2.3	Connecting communication (-C model)	13
2.4	Setting bus address and baud rate.....	14
2.5	Connecting the Drive to Your PC using Ethernet (-D or -IP model).....	16
2.6	Connecting the Power Supply	20
2.7	Choosing A Power Supply.....	21
2.8	Connecting the motor	22
3	Inputs and Outputs.....	23
3.1	Digital Inputs.....	24
3.2	Digital Outputs	26
4	Mounting the Drive	28
5	Reference Materials.....	29
5.1	Drive Mechanical Outlines.....	29
5.2	Technical Specifications	30
5.3	Numbering System.....	31
5.4	Ordering Information	31
5.6	Torque Speed curves	33
5.8	Alarm Code	44
6	Accessories	45
6.2	I/O Cable (Sold separate)	45
6.3	Others.....	46
7	Contacting Applied Motion Products	48

The Information in this manual applies to the following products:

Model	Communication					
	RS485	Modbus/RTU	CANopen	Ethernet	Modbus/TCP	Ethernet/IP
STF03-R	✓	✓				
STF06-R	✓	✓				
STF05-R	✓	✓				
STF10-R	✓	✓				
STF03-C			✓			
STF06-C			✓			
STF05-C			✓			
STF10-C			✓			
STF03-D				✓	✓	
STF06-D				✓	✓	
STF05-D				✓	✓	
STF10-D				✓	✓	
STF03-IP				✓	✓	✓
STF06-IP				✓	✓	✓
STF05-IP				✓	✓	✓
STF10-IP				✓	✓	✓

1 Introduction

Thank you for selecting the Applied Motion Products' STF series stepper drive. The STF series are high performance fieldbus control stepper drive which also integrates with built-in motion controller. The drives can be controlled by SCL, Modbus/RTU, CANopen Modbus/TCP and Ethernet IP in real time. Motion profiles can also be programmed and stored in drives (Q Program) and then be triggered by SCL, Modbus/RTU or CANopen commands. The drives support RS-485/422 or CANopen or Ethernet communication.

1.1 Features

- Programmable, field bus controlled stepper motor drive in compact package
- Operating DC voltage range:
 - STF03 12-48V
 - STF05 24-48V
 - STF06 12-48V
 - STF10 24-70V
- Control Mode
- SCL
 - Serial Communication Command
- Q program
- Stand-Alone operation mode
- Modbus/RTU (-R model only)
- CANopen(-C model only)
 - Compliant with CiA301 and CiA402 standard
- Modbus/TCP (-D and -IP models)
- EtherNet/IP (-IP models)
- Communication
 - R: Dual port RS-485/422
 - C: Dual port CANopen, RS-232 included
 - D: Dual port Ethernet
 - IP: Dual port Ethernet for Ethernet IP
- STF03 output current: max 3A/phase (peak-of-sine)
- STF05 output current: max 5A/phase (peak-of-sine)
- STF06 output current: max 6A/phase (peak-of-sine)
- STF10 output current: max 10A/phase (peak-of-sine)
- I/O
 - 8 optically isolated digital inputs, 5-24VDC high level voltage
 - 4 optically isolated digital outputs, max30V/100mA

1.2 Block Diagram

STF-R Block Diagram

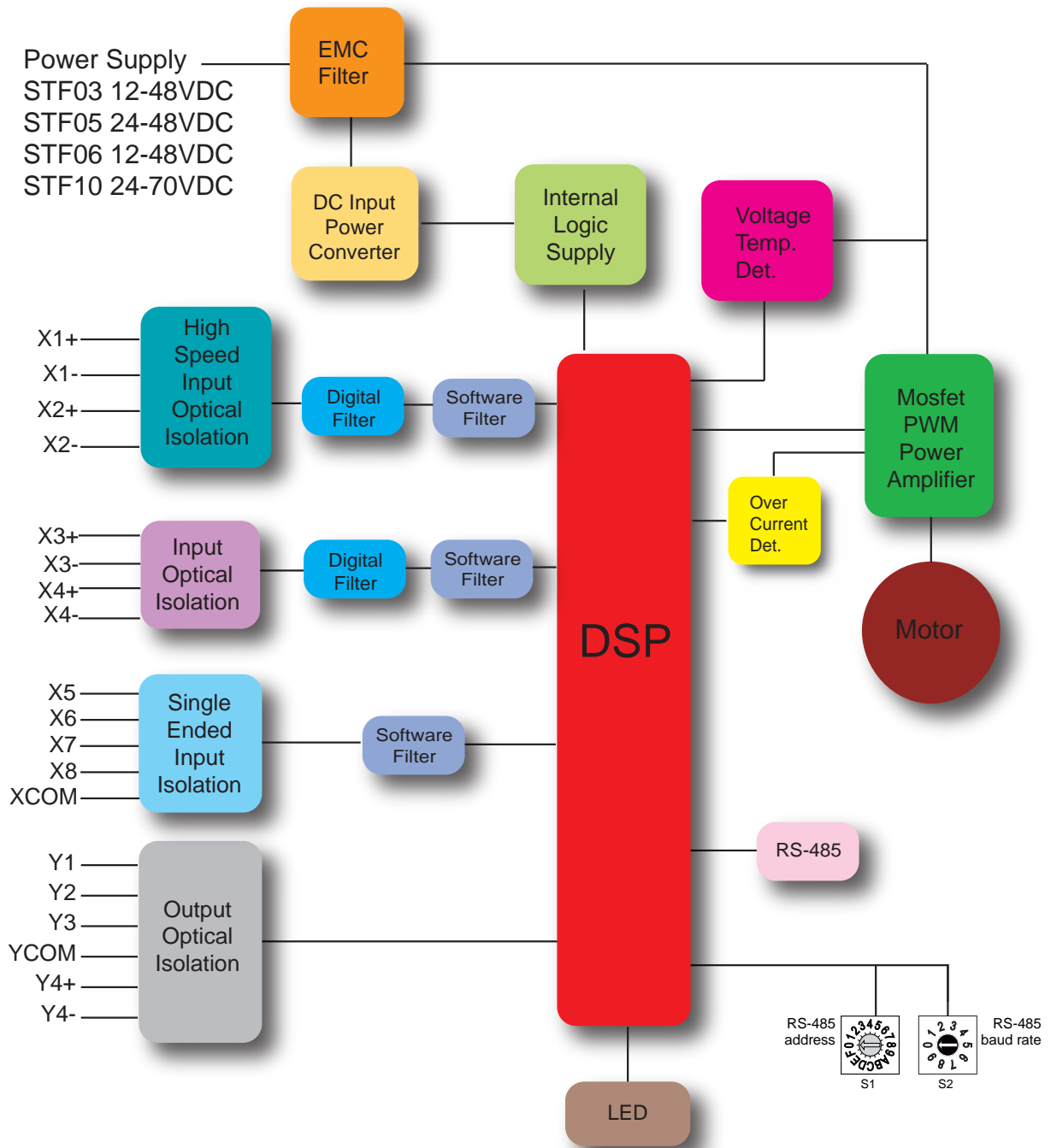

STF-C Block Diagram

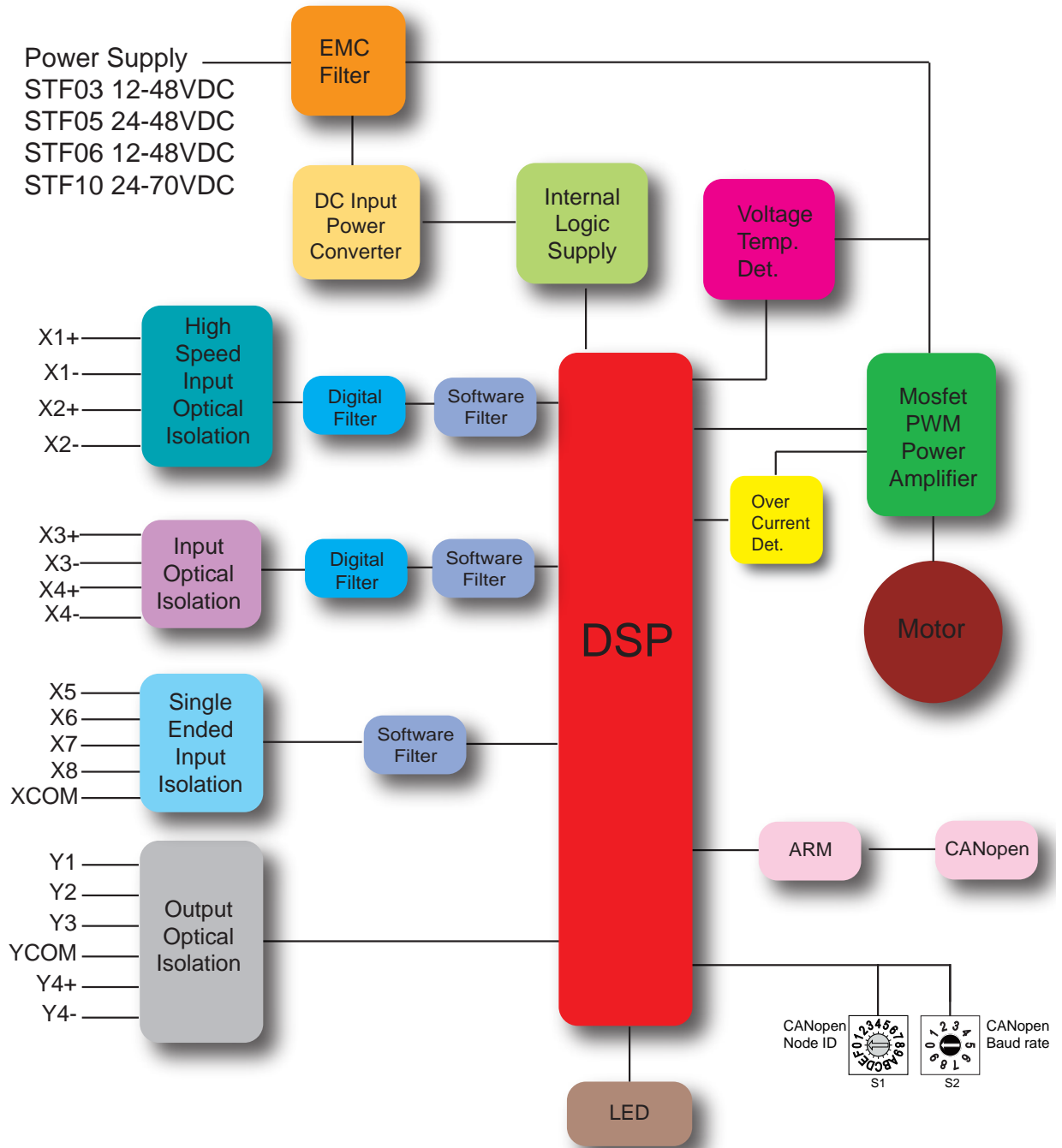

STF-D/IP Block Diagram

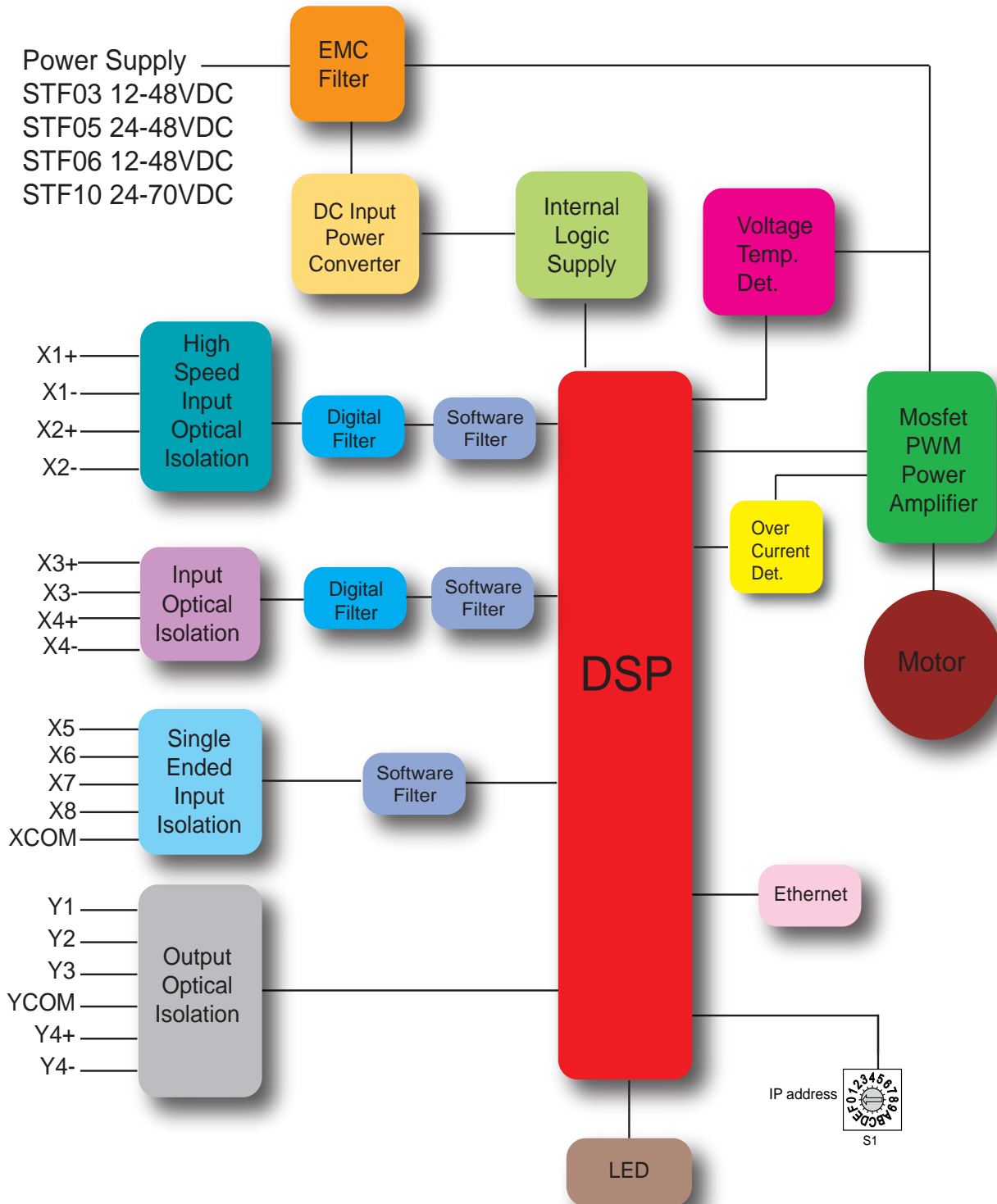

1.3 Safety Instructions

Only qualified personnel should transport, assemble, install, operate, or maintain this equipment. Properly qualified personnel are persons who are familiar with the transport, assembly, installation, operation, and maintenance of motors, and who meet the appropriate qualifications for their jobs.

To minimize the risk of potential safety problems, all applicable local and national codes regulating the installation and operation of equipment should be followed. These codes may vary from area to area and it is the responsibility of the operating personnel to determine which codes should be followed, and to verify that the equipment, installation, and operation are in compliance with the latest revision of these codes.

Equipment damage or serious injury to personnel can result from the failure to follow all applicable codes and standards. Applied Motion Products' does not guarantee the products described in this publication are suitable for a particular application, nor do they assume any responsibility for product design, installation, or operation.

- Read all available documentation before assembly and operation. Incorrect handling of the products referenced in this manual can result in injury and damage to persons and machinery. All technical information concerning the installation requirements must be strictly adhered to.
- It is vital to ensure that all system components are connected to earth ground. Electrical safety is impossible without a low-resistance earth connection.
- This product contains electrostatically sensitive components that can be damaged by incorrect handling. Follow qualified anti-static procedures before touching the product.
- During operation keep all covers and cabinet doors shut to avoid any hazards that could possibly cause severe damage to the product or personal health.
- During operation, the product may have components that are live or have hot surfaces.
- Never plug in or unplug the Integrated Motor while the system is live. The possibility of electric arcing can cause damage.

Be alert to the potential for personal injury. Follow recommended precautions and safe operating practices emphasized with alert symbols. Safety notices in this manual provide important information. Read and be familiar with these instructions before attempting installation, operation, or maintenance. The purpose of this section is to alert users to the possible safety hazards associated with this equipment and the precautions necessary to reduce the risk of personal injury and damage to equipment. Failure to observe these precautions could result in serious bodily injury, damage to the equipment, or operational difficulty.

2 Getting Started

The following items are needed:

- An appropriate power supply, see the section below entitled “Choose a Power Supply” for help in choosing the right one.
- A compatible stepper motor, please see the section below entitled “Recommended Motor”
- A small flat blade screwdriver for tightening the connectors screw(included)
- A PC running Microsoft Windows XP / Vista / Windows 7/ Windows 8 / Windows 10(32-bit or 64-bit)operation system
- Optional I/O cable 3004-348 (Sold separately)
- Install STF Configurator software (Available from Applied Motion Products'website)
- -R model
- A network cable is included in the package. It is used for connection with the next drive in the RS-485 network. It can also be used for connection with PC for drive configuration.
- -C model
- A RS-232 programming cable(included in the package)
- A network cable is included in the package. It is used for connection with the next drive in the CANopen network.
- -D/IP models
- A Ethernet network cable is included in the package. It is used for connection with the next drive in the system or config the drive with host contorller

TIP: When connecting the first drive in the RS-485 or CANopen network with PC or controller. you can cut the daisy chain cable or network cable into two: one half is used for connection with the RS-485 or CANopen port on the PC or controller, the other half can be used for connection with termination resistor, which can be put at the end of the network.

2.1 Installing Software

- Download the STF Configurator Software from the Applied Motion Products' website and install it.
- Launch the software by clicking Start-----Programs ----Applied Motion Products'
- Connect the drive to the PC using communication cable:
- Connect the -R model drive to the RS-485 port of the PC using the network cable included in the package
- Connect the -C model drive to the RS-232 port of the PC using the RS-232 cable included in the package
- Connect the -D/IP model Drive to the Ethernet port of the PC

The connectors and other points of interest are illustrated below:

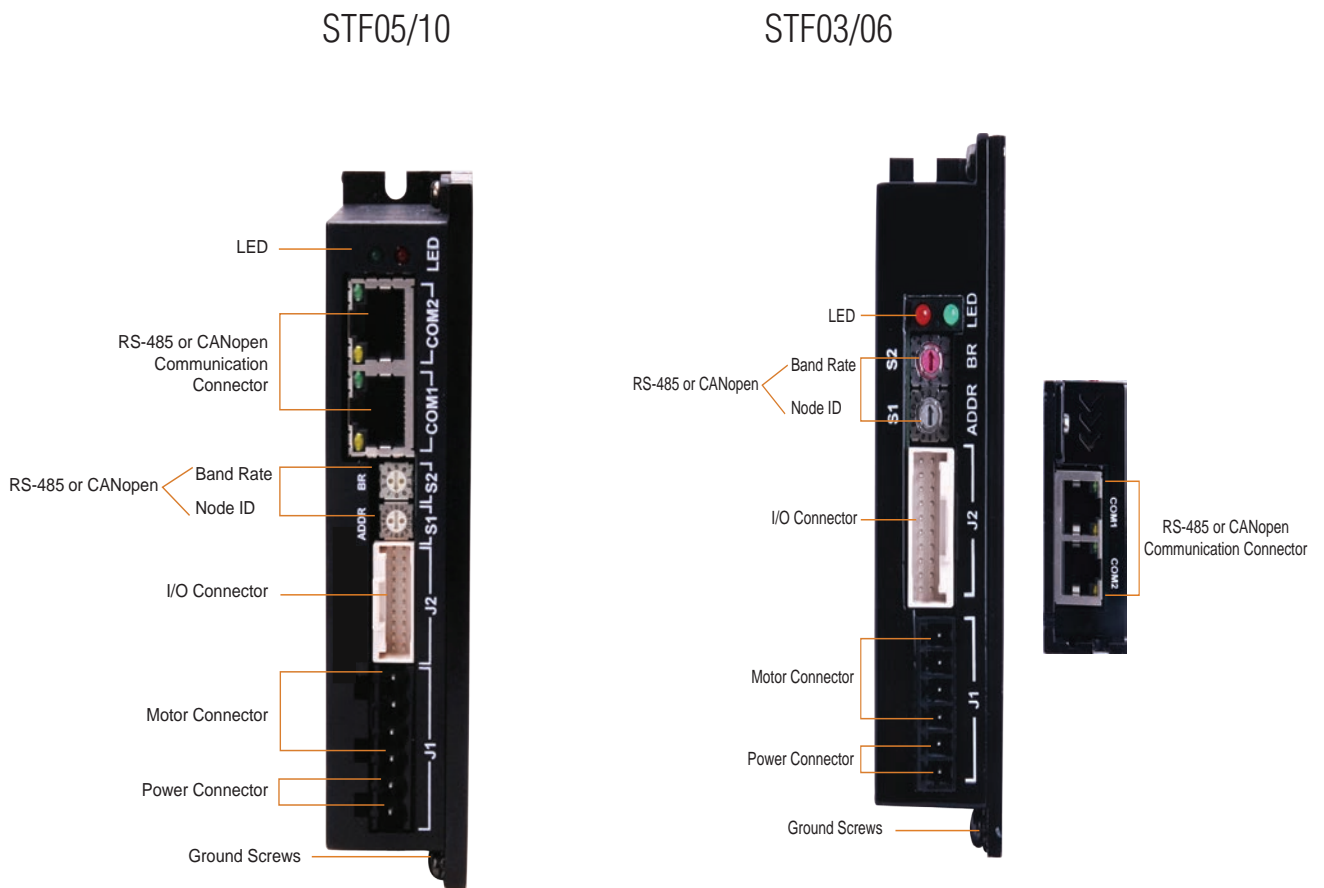

2.2 Connecting Communication (-R model)

RS-485 Port

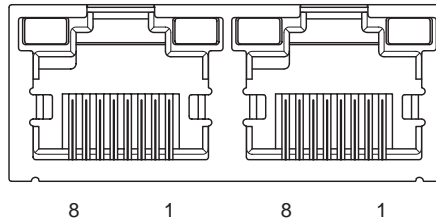

PIN	Signal	Wire Color
1	RX+	ORN/WHT
2	RX-	ORN
3	TX+	GRN/WHT
4.5	NC	BLU, BLU/WHT
6	TX-	GRN
7.8	GND	BRN/WHT, BRN

Connection STF drive with PC using RS-485 communication

Before using **STF configurator** for -R drive configuration, please connect COM1 or COM2 on the driver to host PC by network cable provided. Both 4 wire connection or 2 wire connection can be used.

RS-485 four-wire connection:

Drive	Connection
RX+	Connect to host's TX+
RX-	Connect to host's TX-
TX+	Connect to host's RX+
TX-	Connect to host's RX-
GND	Connect to host's GND

RS-485 two-wire connection:

Drive	Connection
RX+	Connect to host's +
RX-	Connect to host's -
TX+	Connect to host's +
TX-	Connect to host's -
GND	Connect to host's GND

NOTE: The RS-485 port on the drive is isolated from internal circuitry of the drive. So the GND of each drive's RS-485 port must be connected together. The first drive's GND of the RS-485 port must be connected to the GND of RS-485 port on the host PC or controller.

RS-485 network connection

Multiple –R model drive network can be built via dual RS-485 communication port by network cable provided.

RS-485 Four-wire Configuration

RS-485 four-wire system utilize separate transmit and receive wires. One pair of wires connect the host's transmit signals(TX+/TX-) to each drive's RX+/RX- receive terminals. The other pair connects the drive's TX+/TX- terminals to the host's receive signals. A logical ground terminal is provided on each drive and can be used to keep all the drives at the same ground potential. The first drive's logical GND of the RS-485 bus must connect to host's ground.

Four-wire Connection

Connect the drive's RX+ to the TX+ terminal of the host controller, and connect the drive's RX- to the TX- terminal of the host controller . Connect the drive's TX+ to the RX+ terminal of the host controller, and connect the drive's TX- to the RX- terminal of the host controller .

Connect the drive's GND and the host's GND to a same ground.

RS-485 Two-wire Configuration

In a two-wire system ,the data transmitting and receiving use a same cable. the host must stop its transmitting before receiving data. That means the host must stop transmit data before drive begins to answer a query which just come from the host, otherwise the host cannot receive any data witch sent from a drive. There is a transmit delay parameter that can be adjusted to compensate for a host that is slow to disable its transmitter. This adjustment can be set over the network using the TD command, it also can be set by using the **STF Configurator** software. Users can set a shorter transmit delay in a four-wire system.

Two-wire connection

The RX+ and TX+ of the drive connect to the host's + in parallel. The RX- and TX- of the drive connect to the host's - in parallel. Connect the drive's GND and the host's GND to a same ground.

2.3 Connecting communication (-C model)

CANopen COM Port

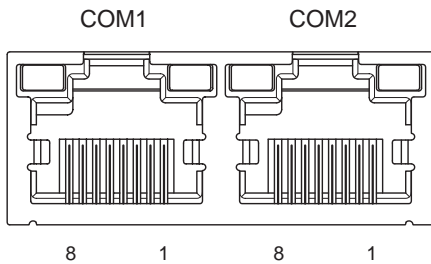

PIN	COM1 Signal	COM2 Signal	Wire Color
1	CAN_H	CAN_H	ORG/WHT
2	CAN_L	CAN_L	ORG
3,7,8	GND	GND	GRN/WHT, BRN/WHT, BRN
4	RS-232_TX	NC	BLU
5	RS-232_RX	NC	BLU/WHT
6	NC	NC	GRN

PC connection with RS-232 cable

Before using STF configurator for -C drive configuration, please connect COM1 on the driver to host PC by RS-232 programming cable.

CANopen network connection

Multiple -C model drive network can be built via dual CANopen communication port by network cable provided.

NOTE: The CANopen port on the drive is isolated from internal circuitry of the drive. So the GND of each drive's CANopen port must be connected together. The first drive's GND of the CANopen port must be connected to the GND of CANopen port on the controller.

2.4 Setting bus address and baud rate

STF drives (-R model and -C model) have two rotary switches to set the bus address and baud rate.

2.4.1 RS-485 address and baud rate settings(-R model)

Set drive's RS-485 address by rotary switch S1

Set drive's RS-485 baud rate by rotary switch S2

S1 is used to set drive's RS-485 address, and the range is 0~F (0~15 in decimal). If you want to set the drive's RS-485 address range to 10~1F (16~31 in decimal), you need to configure it in **STF Configurator** software.

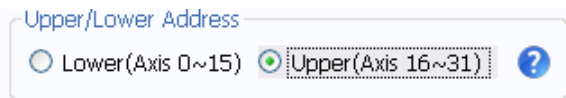
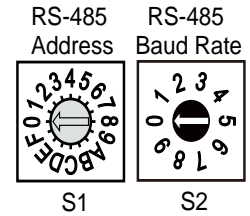

Upper/Lower addr	S1 position	SCL addr	Upper/Lower addr	S1 position	SCL addr
Lower(Axis 0~15)	0	0	Upper(Axis 16~31)	0	@
	1	1		1	!
	2	2		2	"
	3	3		3	#
	4	4		4	\$
	5	5		5	%
	6	6		6	&
	7	7		7	'
	8	8		8	(
	9	9		9)
	A	:		:	*
	B	;		;	+
	C	<		<	,
	D	=		=	-
	E	>		>	.
	F	?		?	/

S2 position	Baud Rate (bps)
0	9600
1	19200
2	38400
3	57600
4	115200
5-9	Reserved

2.4.2 CANopen address and baud rate settings(-C model)

Set drive's CANopen address by rotary switch S1

Set drive's CANopen baud rate by rotary switch S2

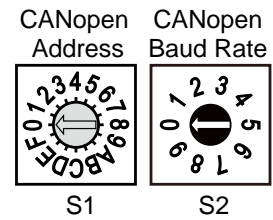

Each node on a CANopen network must have a unique Node ID. Valid ranges for the Node ID are 0x01 through 0x7F (1~127). Node ID 0x00 is reserved in accordance with CiA301. The Node ID is selected using rotary switches and software; one sixteen position switch set the lower four bits (0~F) of node ID, while upper three bits of node ID are configured by **STF Configurator** software. Each time when Node ID is changed, a power cycle is required before the new Node ID is valid.

Please refer to the CANopen manual for more information.

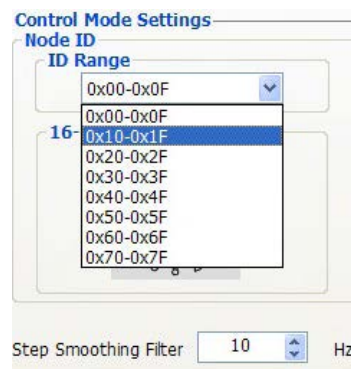

CANopen Baud Rate

There are 8 types of baud rate supported by CANopen communication on STF drive. It is set via S2 switch on the drive

S2 position	Baud Rate (bps)
0	1M
1	800K
2	500K
3	250K
4	125K
5	50K
6	20K
7	12.5K
8-9	Reserved

2.5 Connecting the Drive to Your PC using Ethernet (-D or -IP model)

This process requires three steps

- Physically connect the drive to your network (or directly to the PC)
- Set the drive's IP address
- Set the appropriate networking properties on your PC.

Note: the following pages are an excerpt from the “eSCL Communication Reference Guide”. For more information, please read the rest of the guide.

Addresses, Subnets, and Ports

Every device on an Ethernet network must have a unique IP address. In order for two devices to communicate with each other, they must both be connected to the network and they must have IP addresses that are on the same subnet. A subnet is a logical division of a larger network. Members of one subnet are generally not able to communicate with members of another unless they are connected through special network equipment (e.g. router). Subnets are defined by the choices of IP addresses and subnet masks.

If you want to know the IP address and subnet mask of your PC, select Start...All Programs...Accessories...Command Prompt. Then type “ipconfig” and press Enter. You should see something like this:

If your PC's subnet mask is set to 255.255.255.0, a common setting known as a Class C subnet mask, then your machine can only talk to another network device whose IP address matches yours in the first three octets. (The numbers between the dots in an IP address are called octets.) For example, if your PC is on a Class C subnet and has an IP address of 192.168.0.20, it can talk to a device at 192.168.0.40, but not one at 192.168.1.40. If you change your subnet mask to 255.255.0.0 (Class B) you can talk to any device whose first two octets match yours. Be sure to ask your system administrator before doing this. Your network may be segmented for a reason.

Your drive includes a 16 position rotary switch for setting its IP address. The factory default address for each switch setting is shown in the table on the next page.

Settings 1 through E can be changed using the ST Configurator software (use Quick Tuner for servo drives). Setting 0 is always “10.10.10.10”, the universal recovery address. If someone were to change the other settings and not write it down or tell anyone (I'm not naming names here, but you know who I'm talking about) then you will not be able to communicate with your drive. The only way to “recover” it is to use the universal recovery address.

Setting F is “DHCP”, which commands the drive to get an IP address from a DHCP server on the network. The IP address automatically assigned by the DHCP server may be “dynamic” or “static” depending on how the administrator has configured DHCP. The DHCP setting is reserved for advanced users.

Your PC, or any other device that you use to communicate with the drive, will also have a unique address.

On the drive, switch settings 1 through E use the standard class B subnet mask (i.e. "255.255.0.0"). The mask for the universal recovery address is the standard class A (i.e. "255.0.0.0").

One of the great features of Ethernet is the ability for many applications to share the network at the same time. Ports are used to direct traffic to the right application once it gets to the right IP address. The UDP eSCL port in our drives is 7775. To send and receive commands using TCP, use port number 7776. You'll need to know this when you begin to write your own application. You will also need to choose an open (unused) port number for your application. Our drive doesn't care what that is; when the first command is sent to the drive, the drive will make note of the IP address and port number from which it originated and direct any responses there. The drive will also refuse any traffic from other IP addresses that is headed for the eSCL port. The first application to talk to a drive "owns" the drive. This lock is only reset when the drive powers down.

If you need help choosing a port number for your application, you can find a list of commonly used port numbers at <http://www.iana.org/assignments/port-numbers>.

One final note: Ethernet communication can use one or both of two "transport protocols": UDP and TCP. eSCL commands can be sent and received using either protocol. UDP is simpler and more efficient than TCP, but TCP is more reliable on large or very busy networks where UDP packets might occasionally be dropped.

Option 1: Connect a Drive to Your Local Area Network

If you have a spare port on a switch or router and if you are able to set your drive to an IP address that is compatible with your network, and not used by anything else, this is a simple way to get connected. This technique also allows you to connect multiple drives to your PC. If you are on a corporate network, please check with your system administrator before connecting anything new to the network. He or she should be able assign you a suitable address and help you get going.

If you are not sure which addresses are already used on your network, you can find out using "Angry IP scanner", which can be downloaded free from <http://www.angryip.org/w/Download>. But be careful: an address might appear to be unused because a computer or other device is currently turned off. And many networks use dynamic addressing where a DHCP server assigns addresses "on demand". The address you choose for your drive might get assigned to something else by the DHCP server at another time.

Once you've chosen an appropriate IP address for your drive, set the rotary switch according the address table above. If none of the default addresses are acceptable for your network, you can enter a new table of IP addresses using Configurator. If your network uses addresses starting with 192.168.0, the most common subnet, you will want to choose an address from switch settings 4 through E. Another common subnet is 192.168.1. If your network uses addresses in this range, the compatible default selections are 1, 2 and 3.

If your PC address is not in one of the above private subnets, you will have to change your subnet mask to 255.255.0.0 in order to talk to your drive. To change your subnet mask:

- 1. On Windows XP, right click on "My Network Places" and select properties. On Windows 7, click Computer. Scroll down the left pane until you see "Network". Right click and select properties. Select "Change adapter settings"
- 2. You should see an icon for your network interface card (NIC). Right click and select properties.
- 3. Scroll down until you see "Internet Properties (TCP/IP)". Select this item and click the Properties button. On Windows 7 and Vista, look for "(TCP/IPv4)"
- 4. If the option "Obtain an IP address automatically" is selected, your PC is getting an IP address and a subnet mask from the DHCP server. Please cancel this dialog and proceed to the next section of this manual: "Using DHCP".
- 5. If the option "Use the following IP address" is selected, life is good. Change the subnet mask to "255.255.0.0" and click OK.

Using DHCP

If you want to use your drive on a network that where all or most of the devices use dynamic IP addresses supplied by a DHCP server, set the rotary switch to "F". When the drive is connected to the network and powered on, it will obtain an IP address and a subnet mask from the server that is compatible with your PC. The only catch is that you won't know what address the server assigns to your drive. Ethernet Configurator can find your drive using the Drive Discovery feature, as long as your network isn't too large. With the drive connected to the network and powered on, select Drive Discovery from the Drive menu.

You will see a dialog such as this:

Normally, Drive Discovery will only detect one network interface card (NIC), and will select it automatically. If you are using a laptop and have both wireless and wired network connections, a second NIC may appear. Please select the NIC that you use to connect to the network to which you've connected your drive. Then click OK. Drive Discovery will notify you as soon as it has detected a drive.

If you think this is the correct drive, click Yes. If you're not sure, click Not Sure and Drive Discovery will look for additional drives on you network. Once you've told Drive Discovery which drive is yours, it will automatically enter that drive's IP address in the IP address text box so that you are ready to communicate.

Option 2: Connect a Drive Directly to Your PC

It doesn't get much simpler than this:

1. Connect one end of a CAT5 Ethernet cable into the LAN card (NIC) on your PC and the other into the drive. You don't need a special "crossover cable"; the drive will automatically detect the direct connection and make the necessary physical layer changes.
2. Set the IP address on the drive to "10.10.10.10" by setting the rotary switch at "0".
3. To set the IP address of your PC:
 - a. On Windows XP, right click on "My Network Places" and select properties.
 - b. On Windows 7, click Computer. Scroll down the left pane until you see "Network". Right click and select properties. Select "Change adapter settings"
4. You should see an icon for your network interface card (NIC). Right click and select properties.
 - a. Scroll down until you see "Internet Properties (TCP/IP)". Select this item and click the Properties button.
 - b. On Windows 7 and Vista, look for "(TCP/IPv4)"
5. Select the option "Use the following IP address". Then enter the address "10.10.10.11". This will give your PC an IP address that is on the same subnet as the drive. Windows will know to direct any traffic intended for the drive's IP address to this interface card.
6. Next, enter the subnet mask as "255.255.255.0".
7. Be sure to leave "Default gateway" blank. This will prevent your PC from looking for a router on this subnet.
8. Because you are connected directly to the drive, anytime the drive is not powered on your PC will annoy you with a small message bubble in the corner of your screen saying "The network cable is unplugged."

Option 3: Use Two Network Interface Cards (NICs)

This technique allows you to keep your PC connected to your LAN, but keeps the drive off the LAN, preventing possible IP

conflicts or excessive traffic.

1. If you use a desktop PC and have a spare card slot, install a second NIC and connect it directly to the drive using a CAT5 cable. You don't need a special "crossover cable"; the drive will automatically detect the direct connection and make the necessary physical layer changes.
2. If you use a laptop and only connect to your LAN using wireless networking, you can use the built-in RJ45 Ethernet connection as your second NIC.
3. Set the IP address on the drive to "10.10.10.10" by setting the rotary switch at "0".
4. To set the IP address of the second NIC:
 - a. On Windows XP, right click on "My Network Places" and select properties.
 - b. On Windows 7, click Computer. Scroll down the left pane until you see "Network". Right click and select properties. Select "Change adapter settings"
5. You should see an icon for your newly instated NIC. Right click again and select properties.
 - a. Scroll down until you see "Internet Properties (TCP/IP)". Select this item and click the Properties button.
 - b. On Windows 7 and Vista, look for "(TCP/IPv4)"
6. Select the option "Use the following IP address". Then enter the address "10.10.10.11". This will give your PC an IP address that is on the same subnet as the drive. Windows will know to direct any traffic intended for the drive's IP address to this interface card.
7. Next, enter the subnet mask as "255.255.255.0". Be sure to leave "Default gateway" blank. This will prevent your PC from looking for a router on this subnet.
8. Because you are connected directly to the drive, anytime the drive is not powered on your PC will annoy you with a small message bubble in the corner of your screen saying "The network cable is unplugged."

2.6 Connecting the Power Supply

Connect power supply “+” terminal to the drive terminal labeled “V+”.

Connect power supply “-” terminal to the drive terminal labeled “V-”.

STF03 accepts DC voltage range from 12 – 48VDC

STF05 accepts DC voltage range from 24 – 48VDC

STF06 accepts DC voltage range from 12 – 48VDC

STF10 accepts DC voltage range from 24 – 70VDC

Warning: DO NOT reverse the wires

NOTE: DO NOT apply power until all connections to the drive have been made

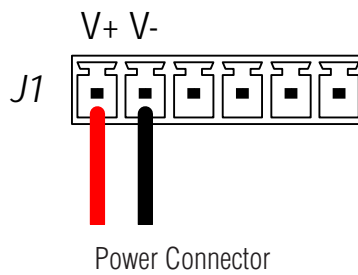

Ensure a proper earth ground connection by using the screw on the left side of the chassis.



Please read “choosing a power supply” for more details

2.7 Choosing A Power Supply

The main considerations when choosing a power supply are the voltage and current requirements of the application.

2.7.1 Voltage

The STF drive and motor is designed to give optimum performance between 24~48 Volts DC. Choosing the voltage depends on the performance needed and diver/motor heating that acceptable and/or does not cause a drive over-temperature. Higher voltage will give higher speed performance, but will cause the drive to produce higher temperatures. Using power supplies with voltage outputs that are near the drive maximum may significantly reduce the operational duty cycle.

STF03/06

The STF03/06 drive extended range of operation voltage can be as low as 11VDC minimum to as high as 53VDC maximum. When operation below 11VDC, the STF03/06 series will work unstable. The supply input cannot go below 11VDC for reliable operation, otherwise under voltage alarm will be triggered. STF03/06 drive will stop working when this alarm is triggered.

If a regulated power supply is used, and that is near the driver maximum voltage of 53VDC, a voltage clamp may be required to prevent the voltage over 53VDC which will occur a overvoltage fault. When using an unregulated power supply, make sure the no-load voltage of the supply does not exceed the maximum input voltage 53VDC.

STF05/10

The STF05/10 drive extended range of operation voltage can be as low as 18VDC minimum to as high as 75VDC maximum for STF10 and 53VDC maximum for STF05. When operation below 18VDC, the STF05/10 series will work unstable. The supply input cannot go below 18VDC for reliable operation, otherwise under voltage alarm will be triggered. STF05/10 drive will stop working when this alarm is triggered.

For STF10 drives, If a regulated power supply is used, and that is near the driver maximum voltage of 75VDC, a voltage clamp may be required to prevent the voltage over 75VDC which will occur a overvoltage fault. When using an unregulated power supply, make sure the no-load voltage of the supply does not exceed the maximum input voltage 75VDC.

For STF05 drives, If a regulated power supply is used, and that is near the driver maximum voltage of 53VDC, a voltage clamp may be required to prevent the voltage over 53VDC which will occur a overvoltage fault. When using an unregulated power supply, make sure the no-load voltage of the supply does not exceed the maximum input voltage 53VDC.

2.7.2 Current

When STF drives work with different motors, the recommended power supply output current capacity under different supply voltage is shown in below table. The STF drive power supply current is lower than the winding currents because it uses switching amplifiers to convert a high voltage and low current into low voltage and high current. The more power supply voltage exceeds the motor voltage, the less current will be required from the power supply.

It is important to note that the current draw is significantly different at higher speeds depending on the torque load to the motor. Estimating how much current is necessary may require a good analysis of the load to the motor.

2.8 Connecting the motor

For Applied Motion Products' stepper motor, please connect black, green, red, blue wires to drive's A+, A-, B+ and B- correspondingly.

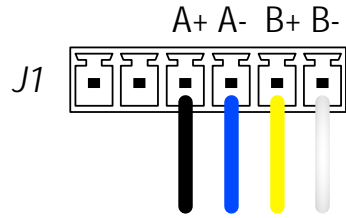

Motor Connector

Never connect or disconnect the motor while the power is on.

If using a non-Applied Motion Products motor, please refer to your motor specs for wiring information. Do not connect it until you have configured the drive for that motor.

Four lead motors can only be connected one way. see below

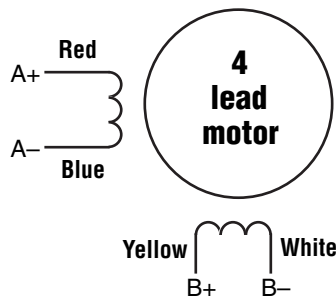

4 Leads

Eight lead motors can also be connected in two ways: series and parallel. As with six lead motors, series operation gives you less torque at high speeds, but may result in lower motor losses and less heating. In series operation, the motor should be operated at 30% less than the unipolar rated current. The motors recommended in this manual should be connected in parallel. The wiring diagrams for eight lead motors are shown on the following page.

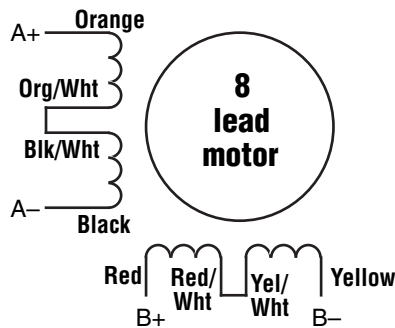

8 Leads Series Connected

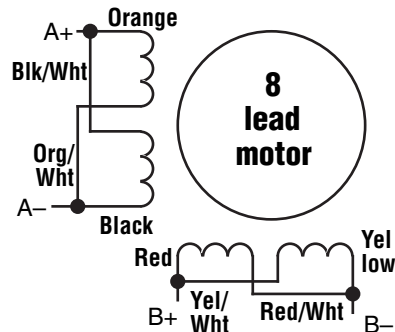

8 Leads Parallel Connected

3 Inputs and Outputs

STF series drive inputs and outputs include:

- * 8 optically isolated digital inputs, 5-24VDC for high level voltage
- * 4 optically isolated digital outputs, maximum voltage 30V, maximum sinking or sourcing current 100mA

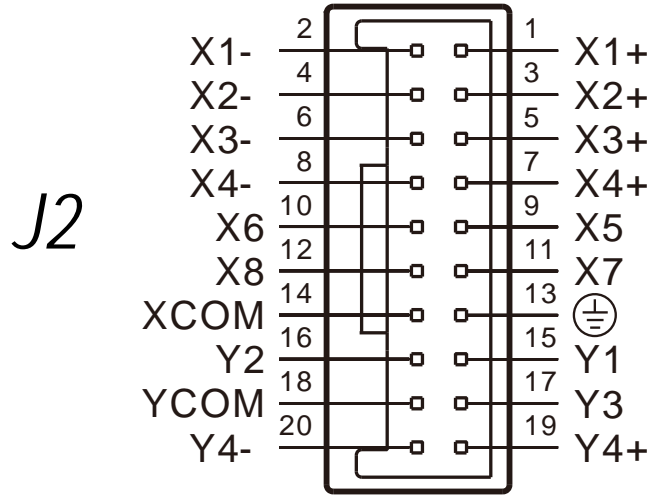

I/O Connector Diagram

3.1 Digital Inputs

3.1.1 X1, X2, X3, X4 digital input signal

X1, X2: optically isolated, differential, 5-24VDC, minimum pulse width 250ns, maximum pulse frequency 2MHz

X3, X4: optically isolated, differential, 5-24VDC, minimum pulse width 100µs, maximum pulse frequency 5KHz

- * X1 can be used as general purpose input.
- * X2 can be used as general purpose input.
- * X3 can be used as CW limit input or general purpose input.
- * X4 can be used as CCW limit input or general purpose input.

Please use STF Configurator software for X1,X2,X3 and X4 function configuration.

Following graphs shows some common connection methods for the inputs:

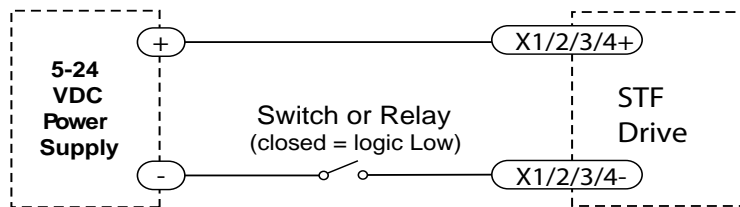

Connecting the inputs to a Switch or Relay

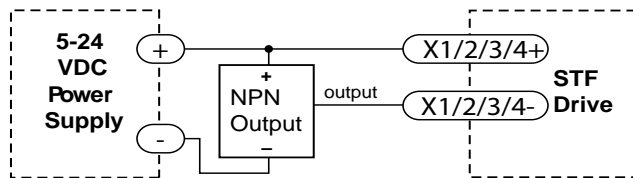

Connecting the inputs to a NPN type output

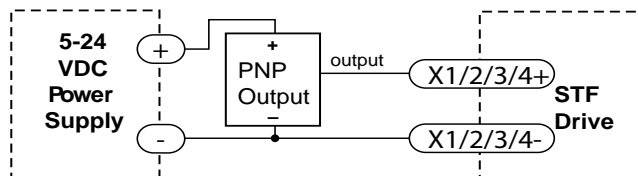

Connecting the inputs to a PNP type output

3.1.2 X5, X6, X7, X8 digital input signal

X5,X6,X7,X8: optically isolated, single-ended, 5-24VDC, minimum pulse width 100µs, maximum pulse frequency 5KHz

- * X5 can be used as enable input or general purpose input.
- * X6 can be used as alarm reset input or general purpose input.
- * X7 can be used as general purpose input.
- * X8 can be used as general purpose input.

Because the input is an optically isolated circuit, a 5-24V power supply is needed. For example, you can use the power supply of the PLC when you are using a PLC control system, but if you want to connect a relay or mechanical switch to the input, you must need a power supply.

XCOM is an electronics term for a single-ended signal connection to a common voltage. In the case of STF series, if you are using a sourcing (PNP) input signals, you need to connect XCOM to the ground (power supply -), if you are using a sinking(NPN) input signals, the XCOM need to connect to the power supply +.

Please use **STF Configurator** software for X5,X6,X7 and X8 function configuration. Following graphs shows some common connection methods for the inputs:

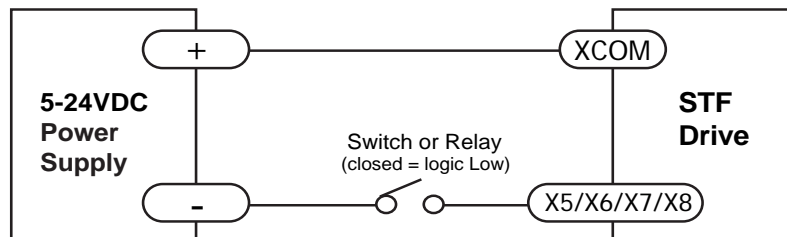

Connecting the inputs to a Switch or Relay

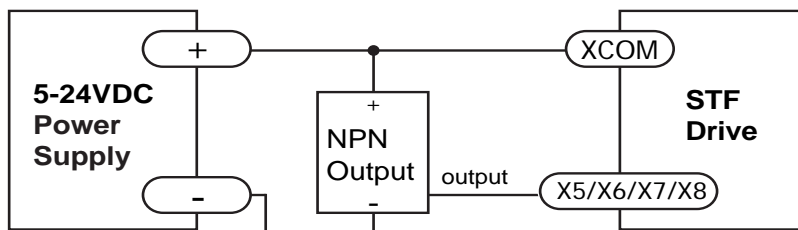

Connecting the inputs to a NPN type output

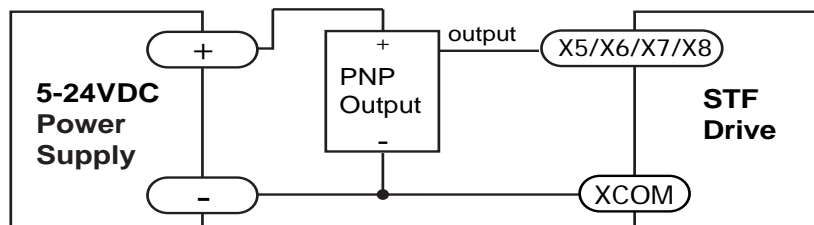

Connecting the inputs to a PNP type output

3.2 Digital Outputs

3.2.1 Y1, Y2, Y3 Digital Outputs

- * Y1 can be used as alarm output, motion status output or general purpose output.
- * Y2 can be used as brake output, motion status output or general purpose output.
- * Y3 can be used as tach-out, timing signal output(50pulse/rev), motion status output or general purpose output.

Please use **STF Configurator** software for Y1,Y2 and Y3 function configuration.

Following graphs shows some common connection methods for the outputs:

NOTE: Do not connect the outputs to more than 30VDC power supply. And the current of each output terminal must not exceed 100mA.

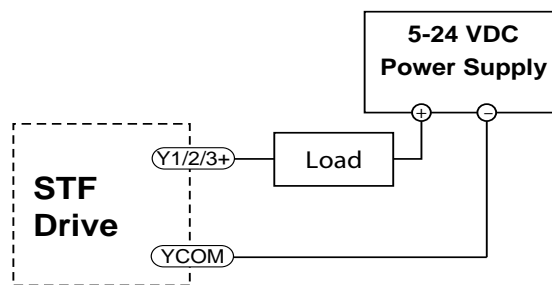

Connecting a sinking output

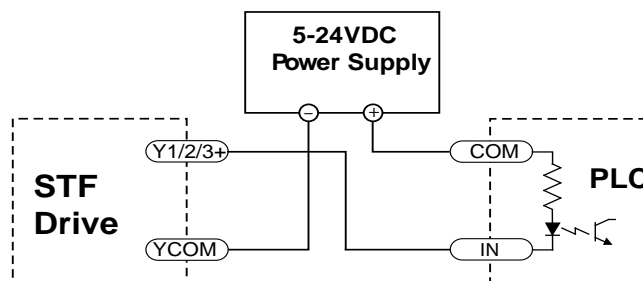

Connecting a sinking output with PLC's input

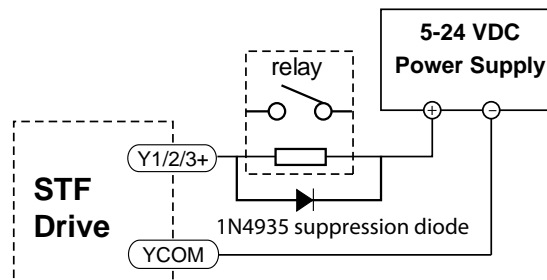

Driving a relay

3.2.2 Y4 Digital Output

Y4 can be used as motion state output or general purpose output.

Please use STF Configurator software for Y4 function configuration.

Following graphs shows some common connection methods for the outputs:

NOTE: Do not connect the outputs to more than 30VDC power supply. And the current of each output terminal must not exceed 100mA.

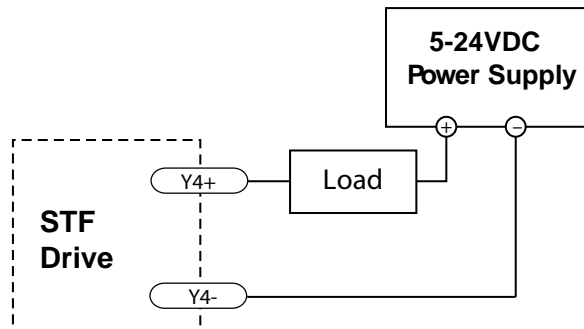

Connecting a sinking output

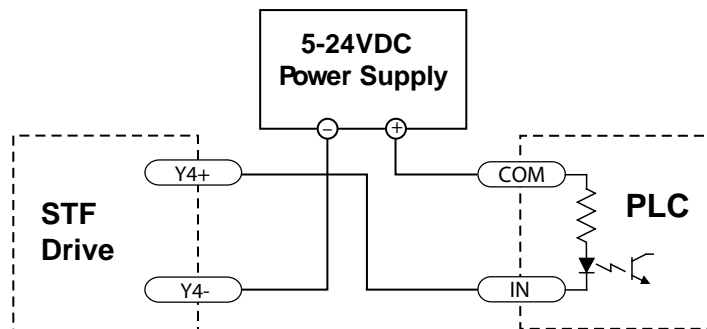

Connecting a sinking output with PLC's input

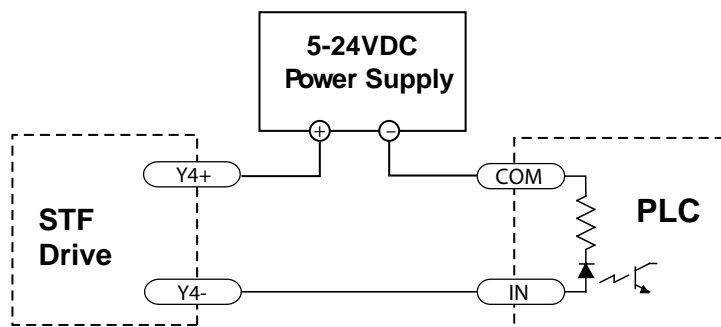

Connecting a sourcing output with PLC's input

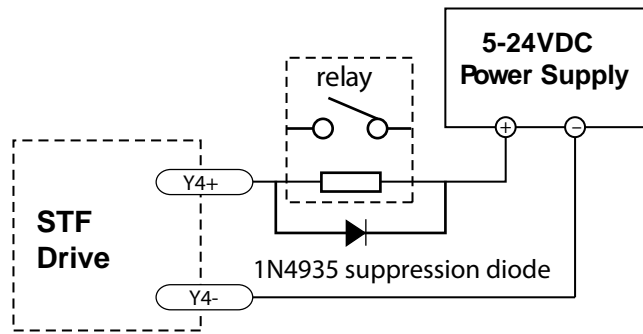

Driving a relay

4 Mounting the Drive

Use the M3 or M4 screw to mount the STF series drive. The drive should be securely fastened to a smooth, flat metal surface that will help conduct heat away from the chassis. If this is not possible, forced airflow from a fan may be required to prevent the drive from overheating.

Never use the drive in a place where there is no air flow or the surrounding air is more than 40°C.



Never put the drive where it can get wet or where metal or other electrically conductive particles can get on the circuitry.

Always provide air flow around the drive. When mounting multiple STF drives near each other, maintain at least 2cm of space between drives.

5 Reference Materials

5.1 Drive Mechanical Outlines

STF03/06

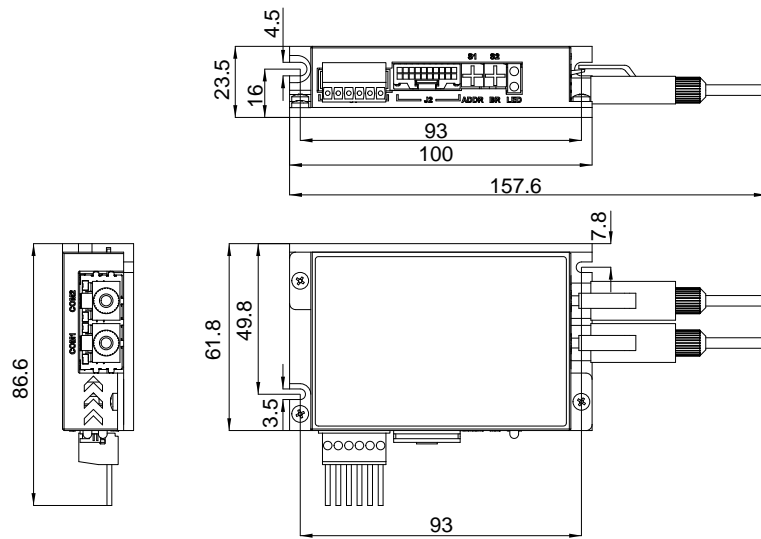

Unit: mm

STF05/10

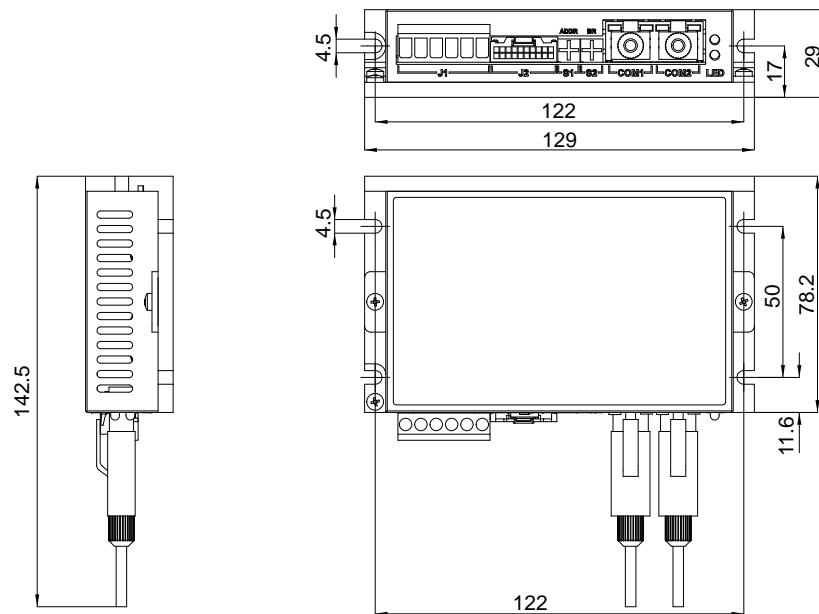

Unit: mm

5.2 Technical Specifications

Power Amplifier	
Amplifier Type	Dual H-Bridge, 4 Quadrant
Current Control	4 state PWM at 20KHz
Output Current	STF03: 0.1 - 3.0A/phase(Peak-of-Sine) in 0.01Amp increment
	STF05: 0.1 - 5.0A/phase(Peak-of-Sine) in 0.01Amp increment
	STF06: 0.1 - 6.0A/phase(Peak-of-Sine) in 0.01Amp increment
	STF10: 0.1 - 10.0A/phase(Peak-of-Sine) in 0.01Amp increment
Rated input voltage	STF03: 12 - 48VDC
	STF05: 24 - 48VDC
	STF06: 12 - 48VDC
	STF10: 24 - 70VDC
Absolute maximum input voltage range	STF03: 11 - 53VDC
	STF05: 18 - 53VDC
	STF06: 11 - 53VDC
	STF10: 18 - 75VDC
Protection	Over voltage, under voltage, over temp, over current, open winding, communication cable disconnection
Idle Current Reduction	Reduction range of 0 - 90% of running current after a delay selectable in milliseconds
Controller	
Anti-Resonance	Raises the system-damping ratio to eliminate midrange instability and allow stable operation throughout the speed range of the motor
Torque Ripple Smoothing	Allows for fine adjustment of phase current waveform harmonic content to reduce low-speed torque ripple in the range of 0.25 to 1.5 rps
Auto Test & Auto Setup	Auto test and setup at power on (ie. motor resistance, and capacitance) to optimize your system performance.
Non-Volatile Storage	Configurations are saved in FLASH memory on-board the DSP
Operation Mode	R: SCL, Q program, Modbus C: Compliant with CiA301 and CiA402 standard D: eSCL, Q program, Modbus IP: Ethernet/IP, eSCL, Q program, Modbus
Digital Input	8 digital inputs
	X1, X2: Optically isolated, differential, 5-24VDC for high level voltage, minimum pulse width = 250ns, maximum pulse frequency = 2MHz
	X3, X4: Optically isolated, differential, 5-24VDC for high level voltage, minimum pulse width = 100µs, maximum pulse frequency = 5KHz
	X5 ~ X8: Optically isolated, single-ended, 5-24VDC for high level voltage, minimum pulse width = 100µs, maximum pulse frequency = 5KHz
Digital Output	4 digital outputs Y1 ~ Y4: Optically isolated, maximum voltage 30V, maximum sinking or sourcing current 100mA

Communication Interface	R model: dual port RS-485 (RJ45 connector)
	C model: dual port CANopen (RJ45 connector) RS-232 included
	D model: dual port Ethernet
	IP model: dual port Ethernet
Physical	
Ambient Temperature	0-40 °C (32-104 °F)(when mounted to a suitable heat sink)
Humidity	90% non-condensing

5.3 Numbering System

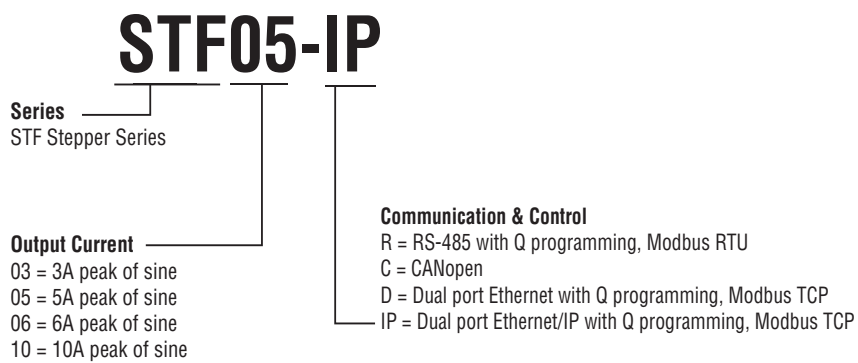

5.4 Ordering Information

Model	Voltage	RS-485	Modbus/RTU	CANopen	Ethernet	Modbus/TCP	Ethernet/IP
STF03-R	12 - 48 VDC	✓	✓				
STF05-R	24 - 48 VDC	✓	✓				
STF06-R	12 - 48 VDC	✓	✓				
STF10-R	24 - 70 VDC	✓	✓				
STF03-C	12 - 48 VDC			✓			
STF05-C	24 - 48 VDC			✓			
STF06-C	12 - 48 VDC			✓			
STF10-C	24 - 70 VDC			✓			
STF03-D	12 - 48 VDC				✓	✓	
STF05-D	24 - 48 VDC				✓	✓	
STF06-D	12 - 48 VDC				✓	✓	
STF10-D	24 - 70 VDC				✓	✓	
STF03-IP	12 - 48 VDC				✓	✓	✓
STF05-IP	24 - 48 VDC				✓	✓	✓
STF06-IP	12 - 48 VDC				✓	✓	✓
STF10-IP	24 - 70 VDC				✓	✓	✓

5.5 Recommended Motors

Part Number	Holding Torque		Current Setting	Resistance	Inductance	Inertia
	oz-in	kg-cm				
HT11-012/212	7.0	0.50	1.2	1.4	1.4	8
HT11-013/213	15.0	1.08	1.2	2.0	2.6	18
5014-042/842	26.0	1.87	1.2	4.3	5.5	20
HT17-068/268 #	31.4	2.26	1.6	2.1	2.8	35
HT17-071/271 #	51.0	3.67	2.0	1.7	3.6	54
HT17-075/275 #	62.8	4.52	2.0	1.7	3.0	68
HT23-394/594 #	76.6	5.52	3.4	0.7	1.4	120
HT23-398/598 #	177	12.7	5.0	0.4	1.2	300
HT23-401/601 #	264	19.0	5.0	0.5	1.6	480
HT23-603	354	25.48	6.0	0.5	2.2	750
HT24-100	123.2	8.87	3.36	0.73	1.6	260
HT24-105	177	12.74	4.8	0.43	1.1	450
HT24-108	354	25.48	4.8	0.65	2.4	900
HT34-486 #	1200	86.4	9.7	0.27	2.2	2680
HT34-487 #	1845	133	10.0	0.27	2.4	4000
HT34-504	396.5	28.55	7.56	0.24	1.7	1100
HT34-505	849.6	61.18	7.56	0.33	2.7	1850
HT34-506	1260	90.75	6.72	0.63	5.4	2750

Note: The “Drive Current Setting” shown here differs from the rated current of each motor because the rated current is RMS and the drive current setting is peak sine. If you are using a motor not listed here, for best results set the drive current at the motor’s rated current x 1.2.

Indicates values are with motor connected in Parallel.

5.6 Torque Speed curves

HT11-012/212, HT11-013/213, 5014-042/842

24 VDC power supply, 20000 steps/rev

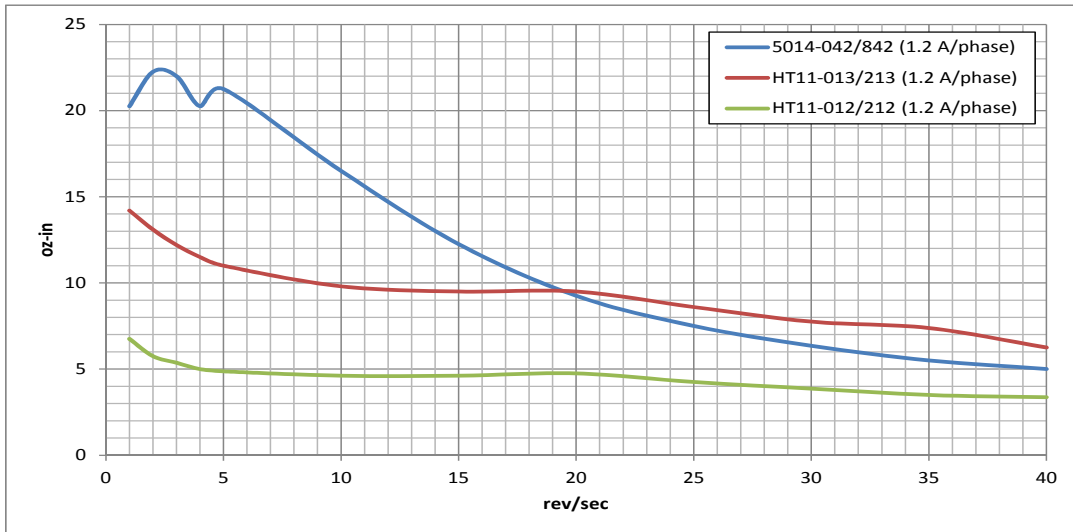

HT17

24 VDC power supply, 20000 steps/rev, all motors connected in parallel

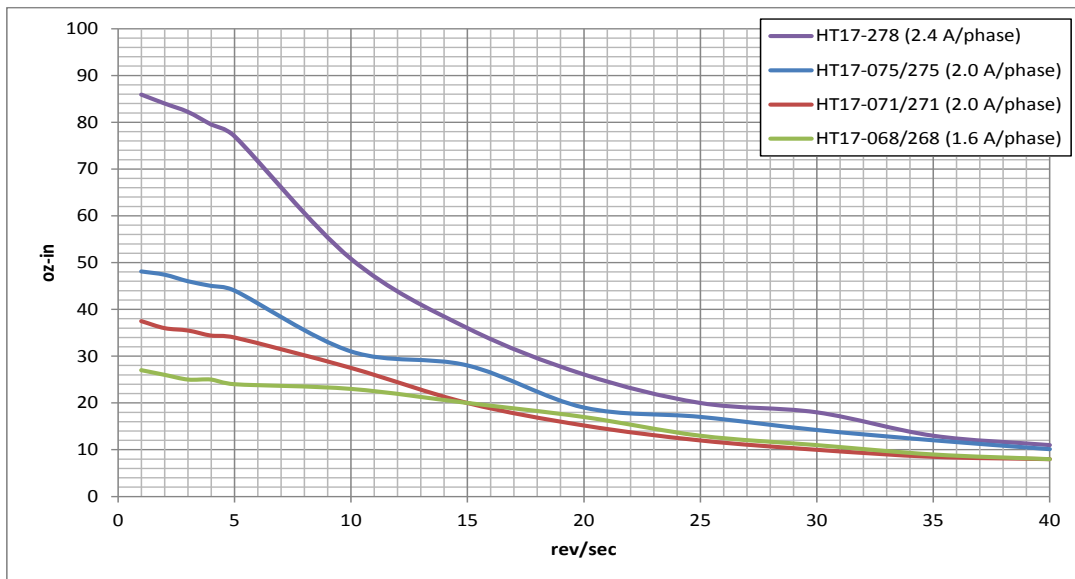

HT17

48 VDC power supply, 20000 steps/rev, all motors connected in parallel

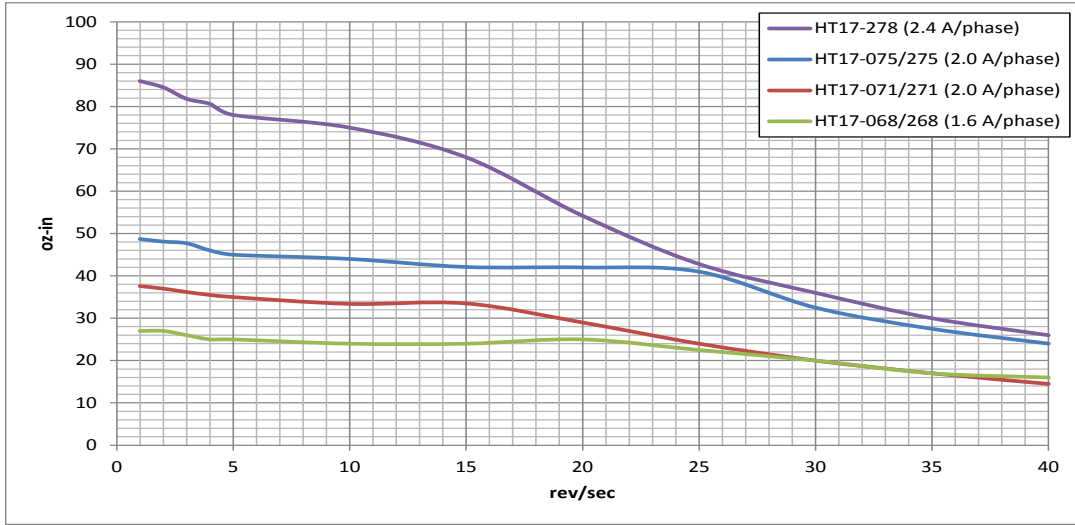

HT23

24 VDC power supply, 20000 steps/rev, all motors connected in parallel

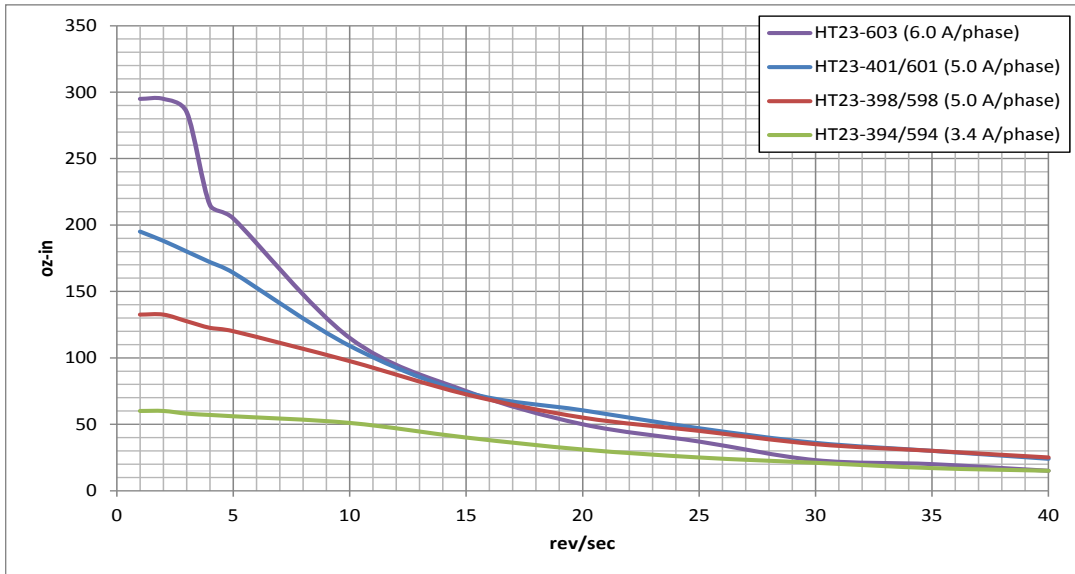

HT23

48 VDC power supply, 20000 steps/rev, all motors connected in parallel

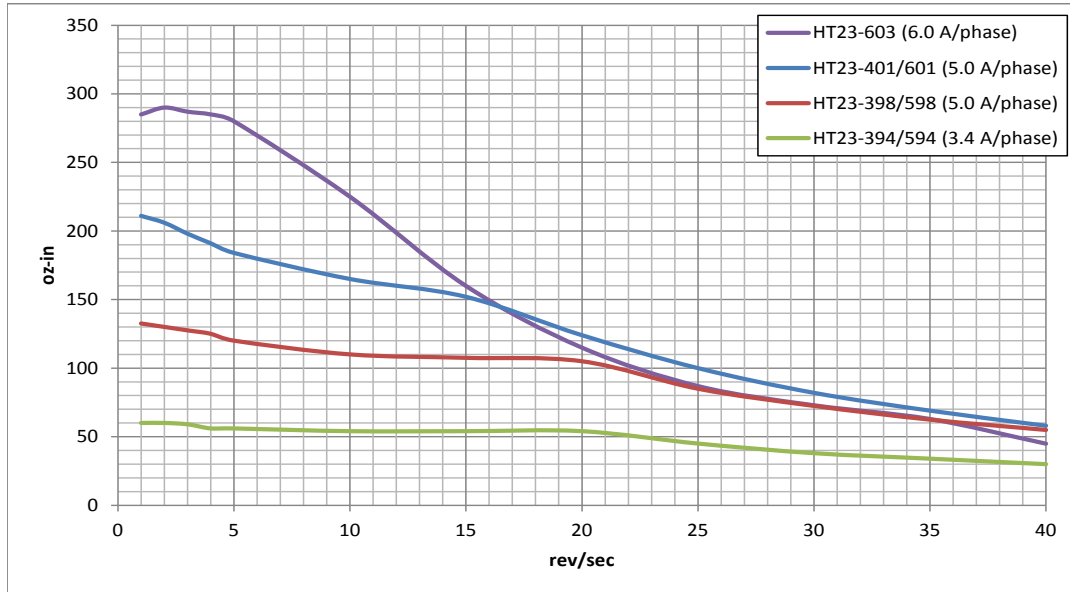

HT24

24 VDC power supply, 20000 steps/rev

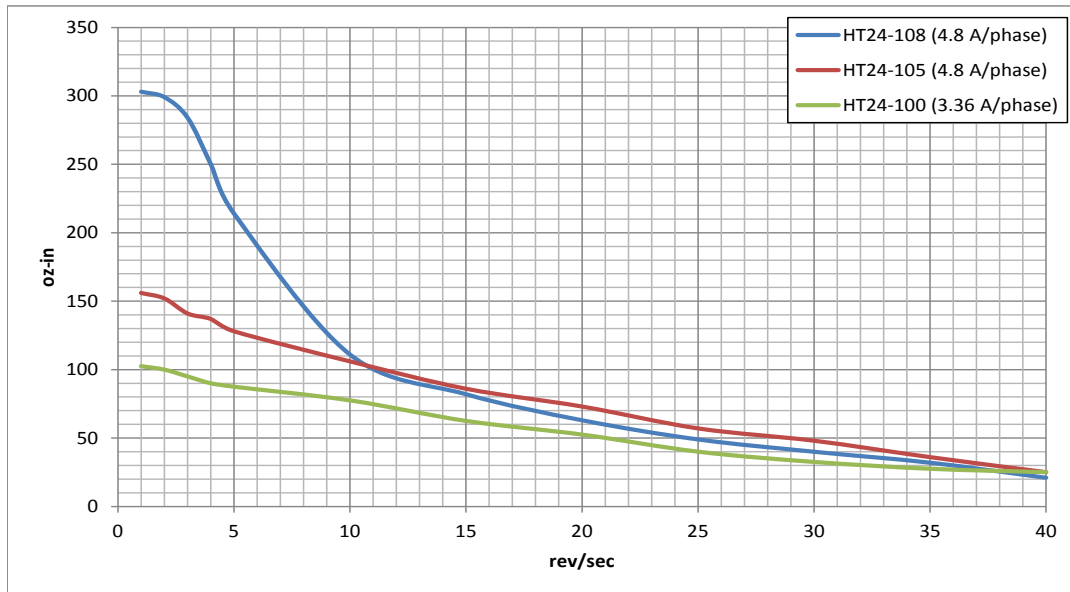

HT24

48 VDC power supply, 20000 steps/rev

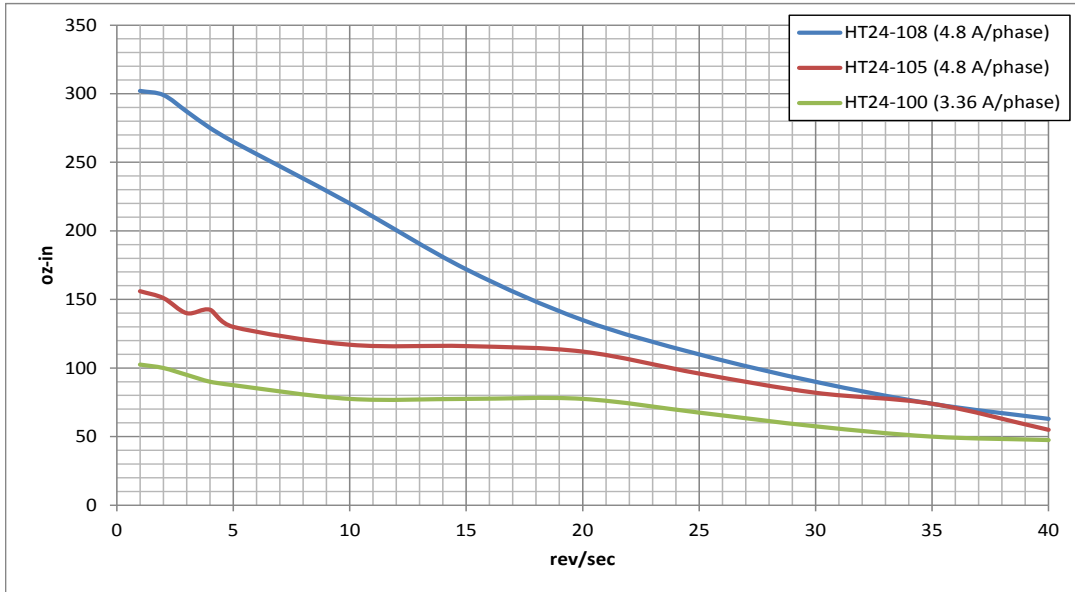

HT34-485/486/487

24 VDC power supply, 20000 steps/rev, all motors connected in parallel

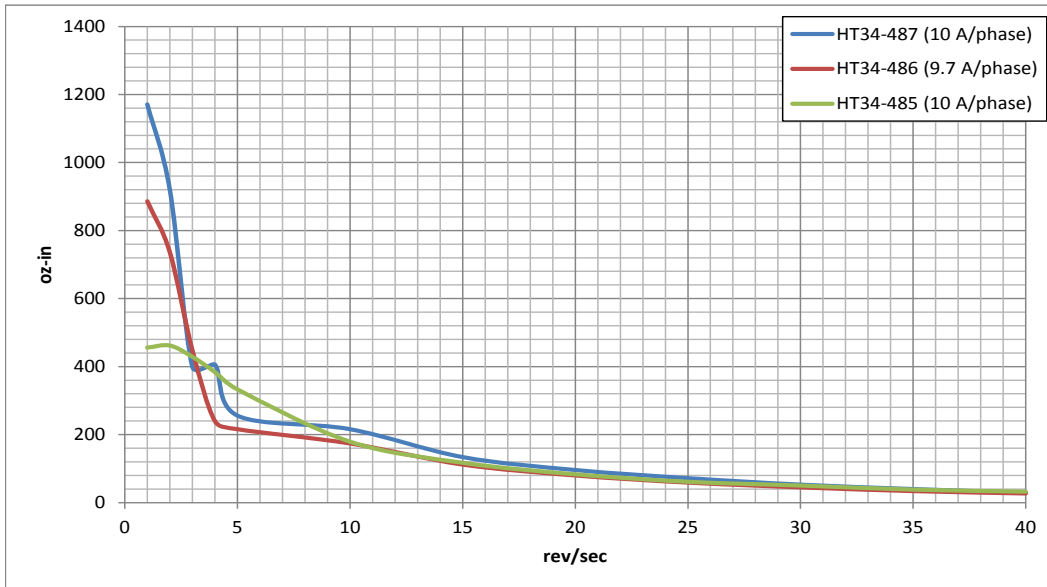

HT34-485/486/487

48 VDC power supply, 20000 steps/rev, all motors connected in parallel

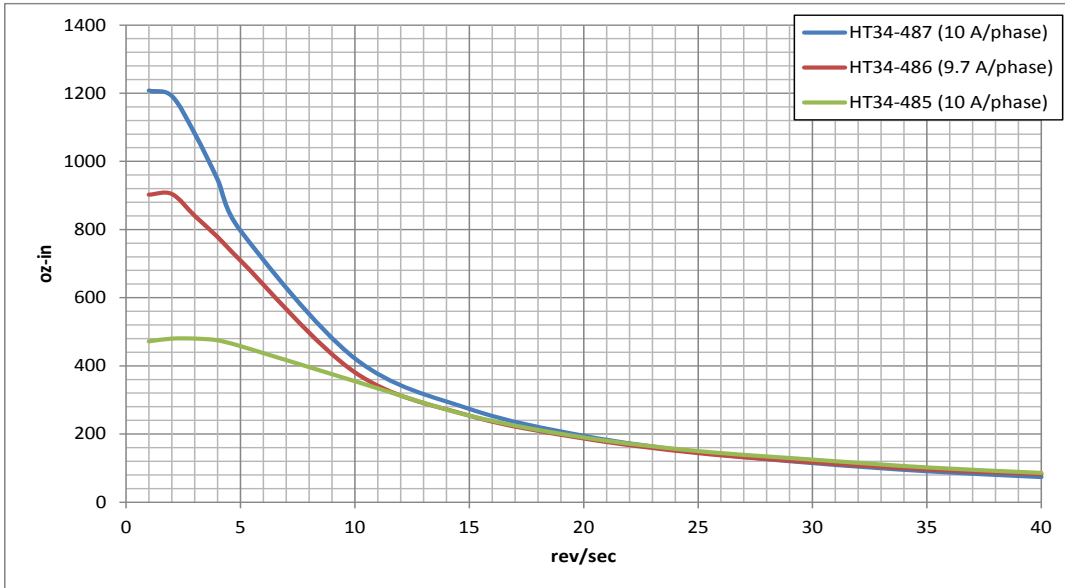

HT34-485/486/487

80 VDC power supply, 20000 steps/rev, all motors connected in parallel

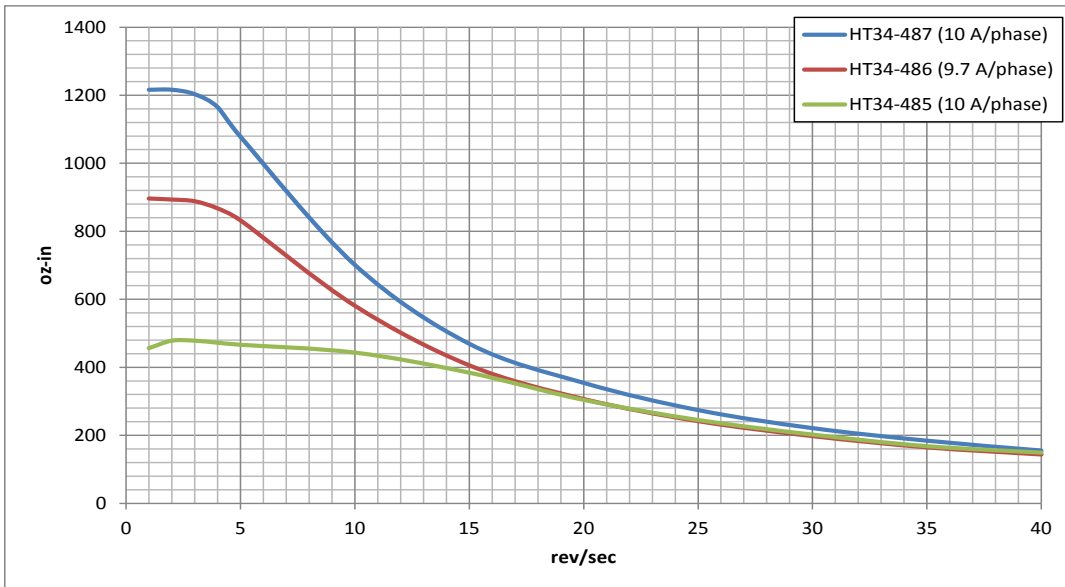

HT34-504/505/506

24 VDC power supply, 20000 steps/rev, all motors connected in parallel

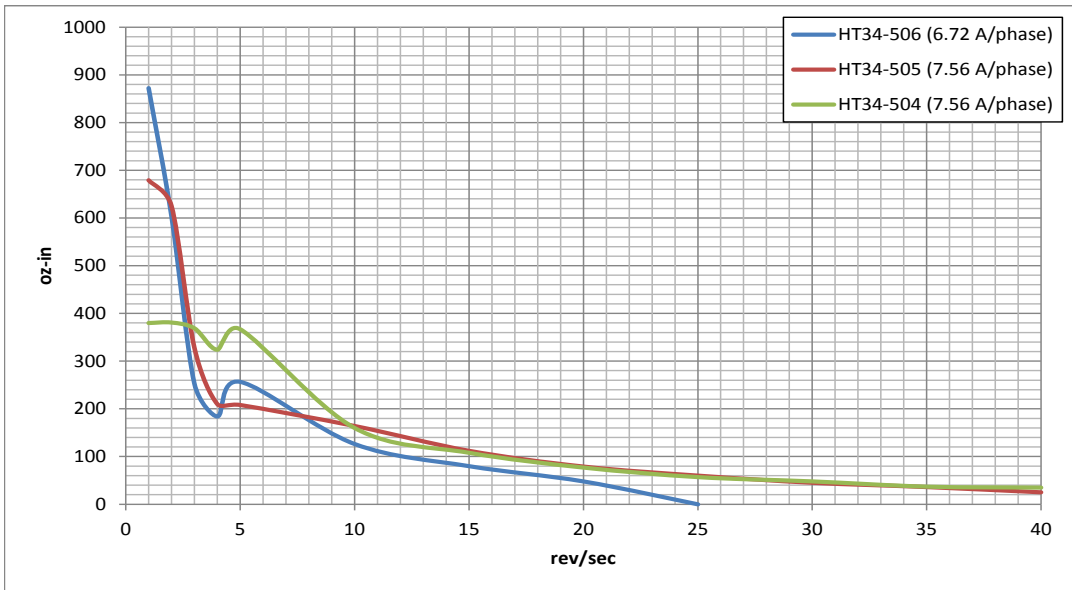

HT34-504/505/506

48 VDC power supply, 20000 steps/rev, all motors connected in parallel

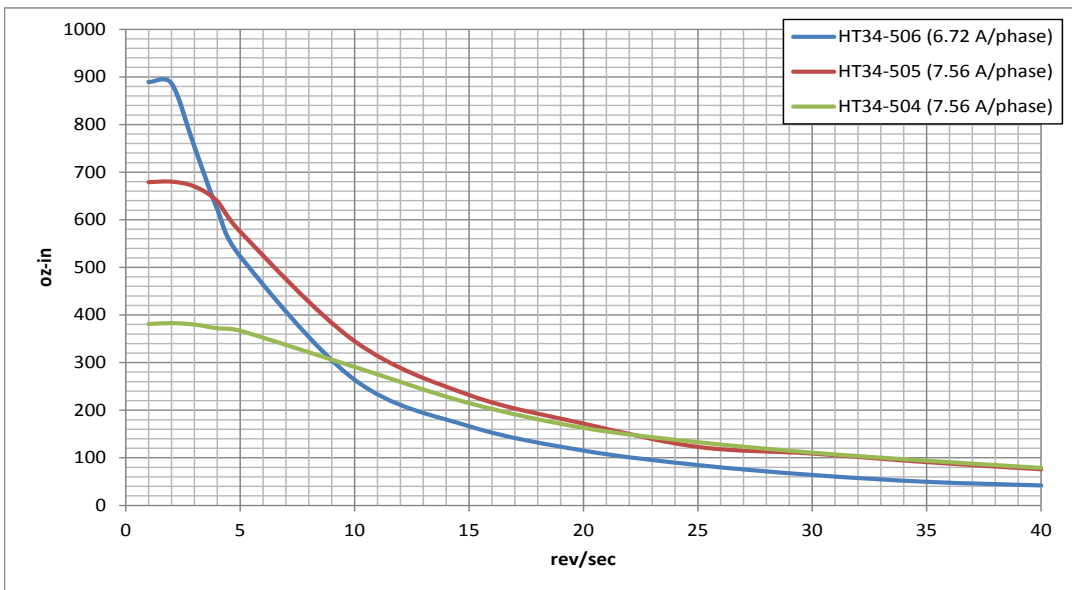

HT34-504/505/506

60 VDC power supply, 20000 steps/rev, all motors connected in parallel

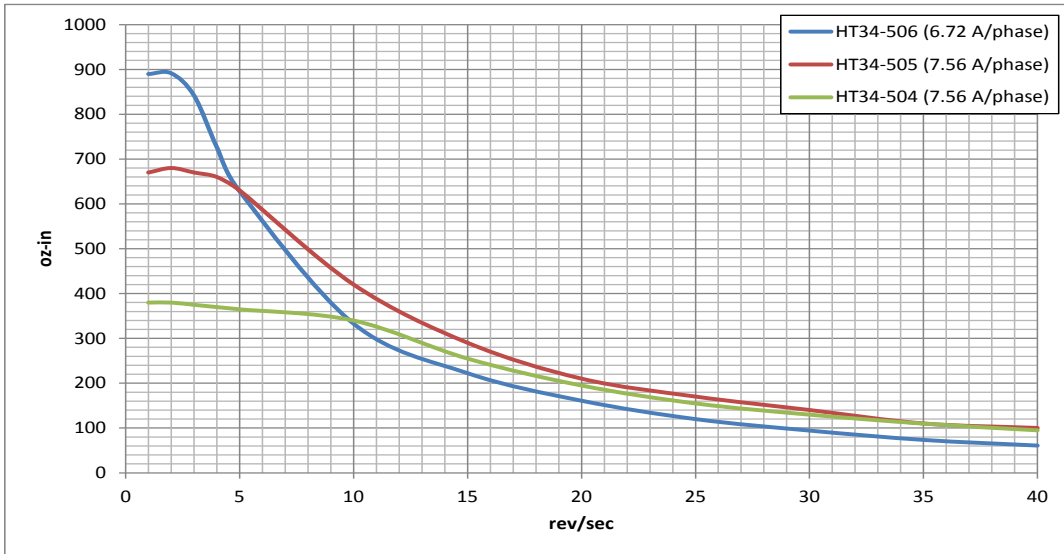

5.7 Motor Heating

Step motors convert electrical power from the driver into mechanical power to move a load. Because step motors are not perfectly efficient, some of the electrical power turns into heat on its way through the motor. This heating is not so much dependent on the load being driven but rather the motor speed and power supply voltage. There are certain combinations of speed and voltage at which a motor cannot be continuously operated without damage.

We have characterized the recommended motors in our lab and provided curves showing the maximum duty cycle versus speed for each motor at commonly used power supply voltages. Please refer to these curves when planning your application.

Please also keep in mind that a step motor typically reaches maximum temperature after 30 to 45 minutes of operation. If you run the motor for one minute then let it sit idle for one minute, that is a 50% duty cycle. Five minutes on and five minutes off is also 50% duty. However, one hour on and one hour off has the effect of 100% duty because during the first hour the motor will reach full (and possibly excessive) temperature.

The actual temperature of the motor depends on how much heat is conducted, convected or radiated out of it. Our measurements were made in a 40°C (104°F) environment with the motor mounted to an aluminum plate sized to provide a surface area consistent with the motor power dissipation. Your results may vary.

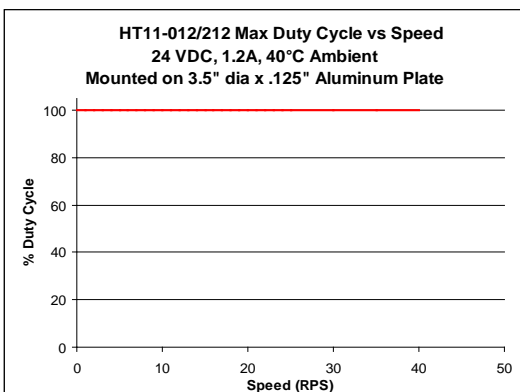
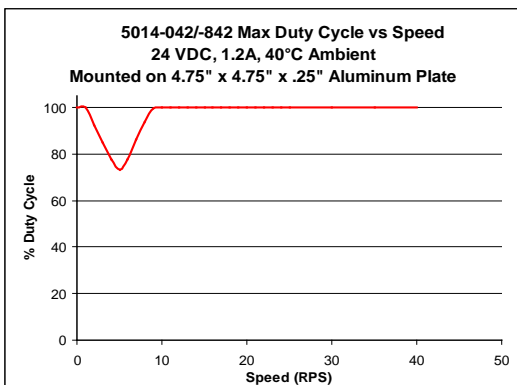

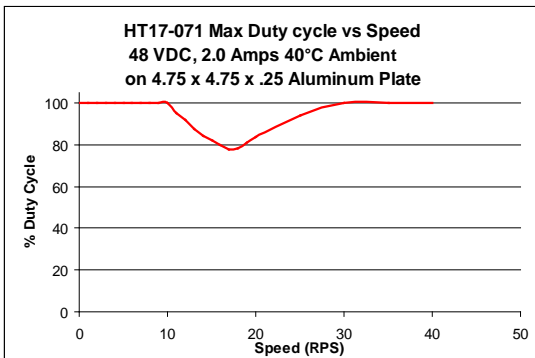
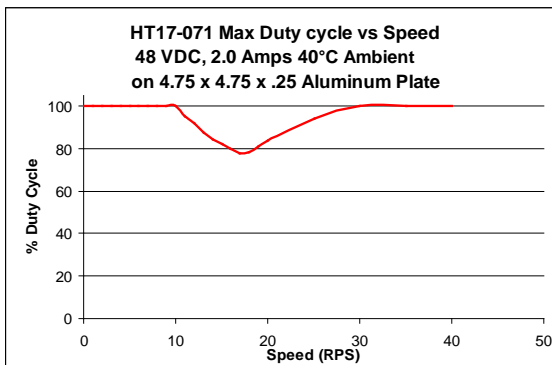
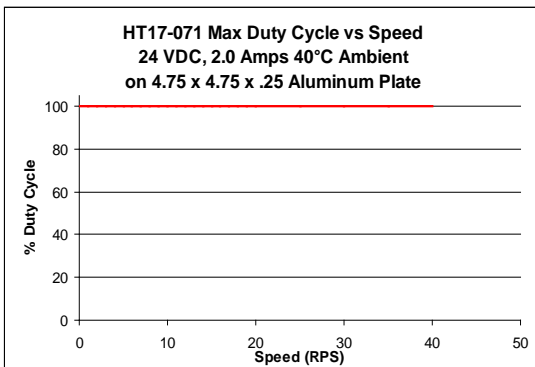
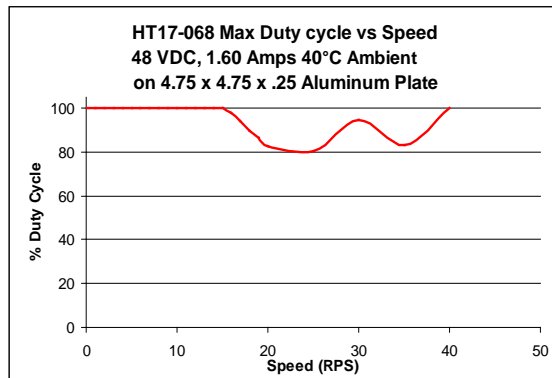
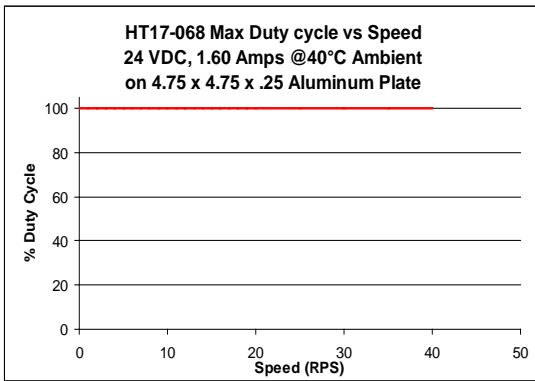
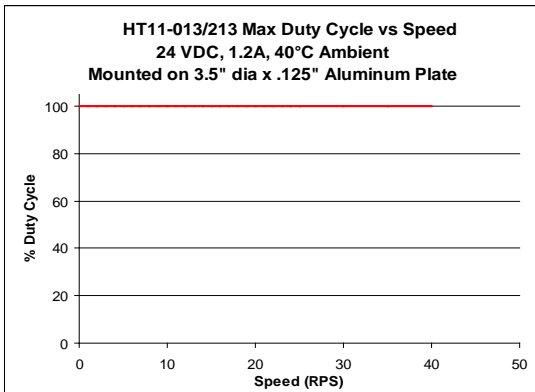



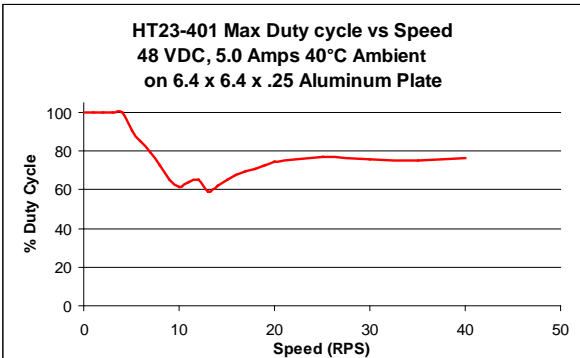
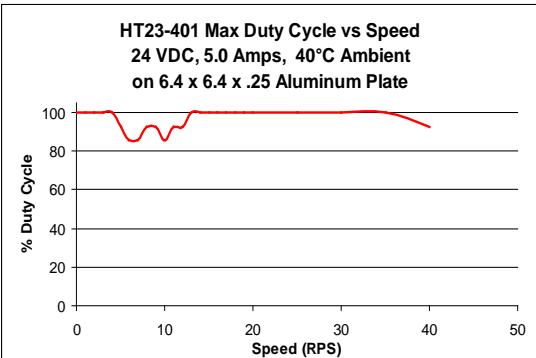
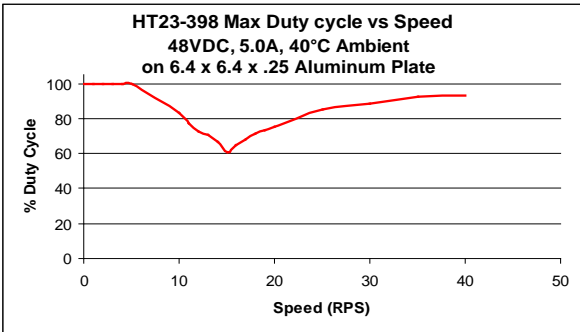
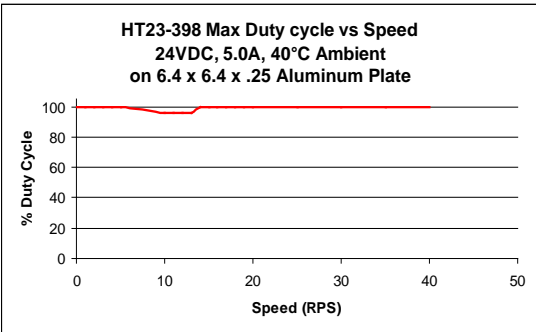
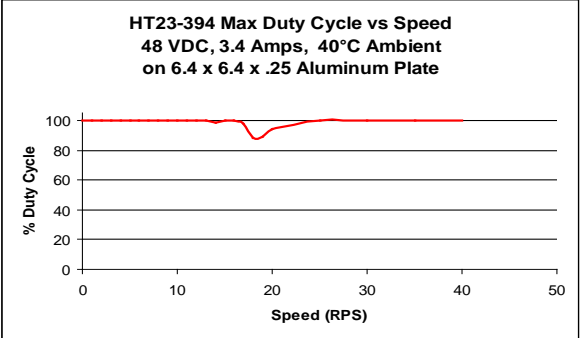
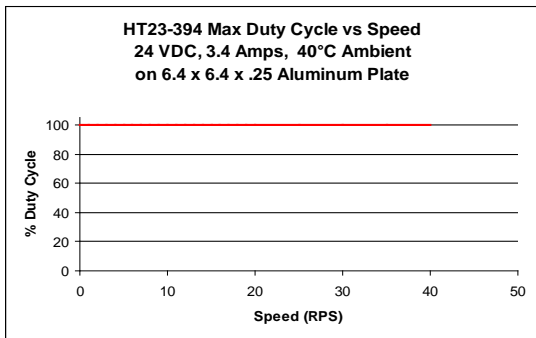
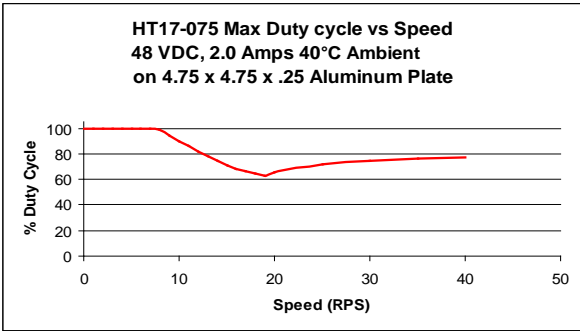
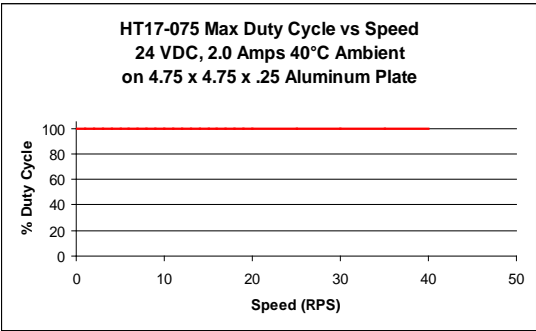

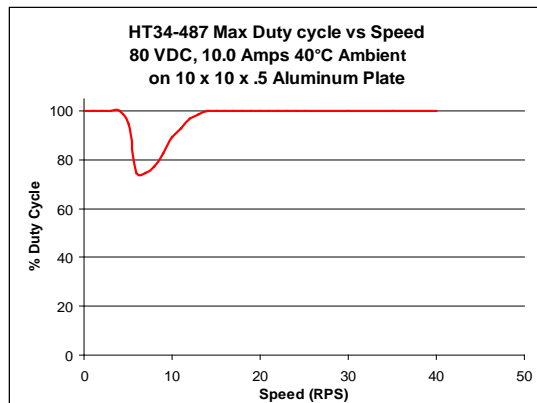
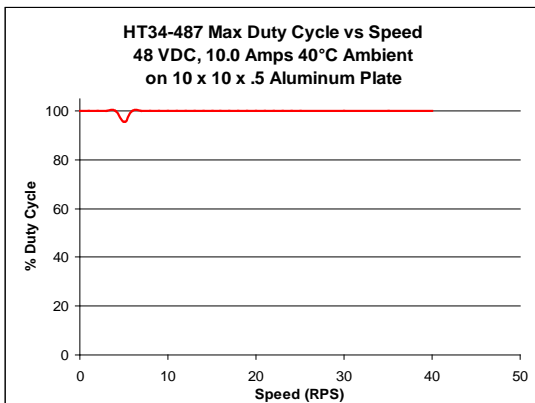
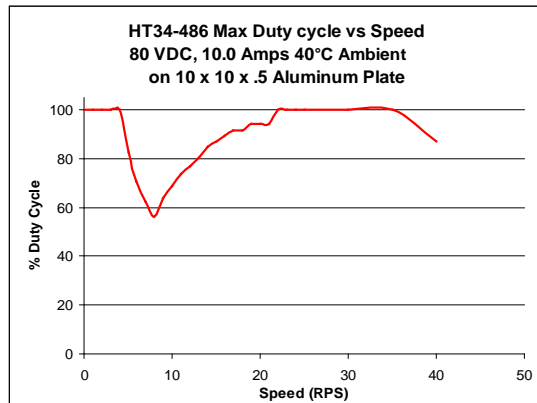
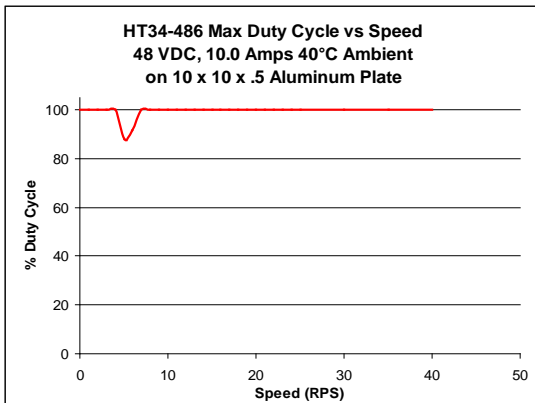
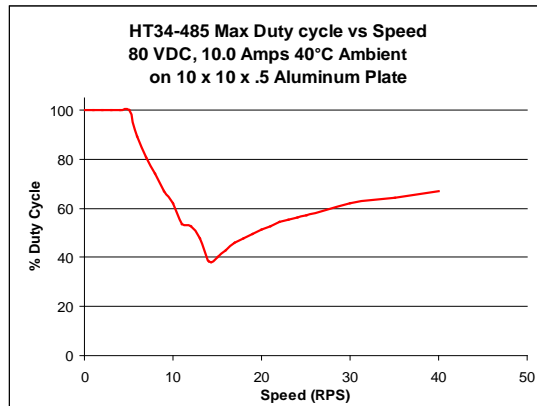
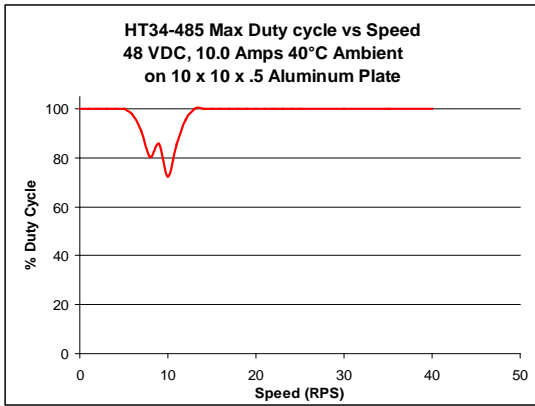







STF-R/C/D/IP Hardware Manual





5.8 Alarm Code

Code	Error
	solid green no alarm,motor disabled
	flashing green no alarm,motor enabled
	1 red, 2 green move while disabled
	2 red, 1 green CCW limit
	2 red, 2 green CW limit
	3 red, 1 green drive over temperature
	3 red, 2 green internal voltage bad
	3 red, 3 green blank Q segment
	4 red, 1 green over voltage
	4 red, 2 green under voltage
	5 red, 1 green over current
	6 red, 1 green open motor winding
	7 red, 1 green communication error

NOTE: Items in bold italic represent Drive Faults, which automatically disable the motor.

6 Accessories

Mating Connector (included in drive package)

STF05/10

Part	Description	Part Number	Vendor	Qty
J1	Power & Motor Connector	2EDGK-5.08-06P-13-1000AH	DEGSON	1
J2	I/O Connector Housing	501646-2000	Molex	1
J2	I/O Connector Crimp	501648-1000	Molex	20

STF03/06

Part	Description	Part Number	Vendor	Qty
J1	Power & Motor Connector	BCP-381-6 BK	Phoenix	1
J2	I/O Connector Housing	501646-2000	Molex	1
J2	I/O Connector Crimp	501648-1000	Molex	20

6.2 I/O Cable (Sold separate)

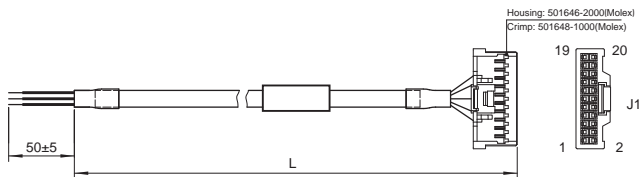

P/N	Length
3004-348	2m

Pin No.	Assignment	Description	Color	Pin No.	Assignment	Description	Color
1	X1+	X1 Digital Input	Blue/White	11	X7	X7 Digital Input	Yellow
2	X1-		Blue/Black	12	X8	X8 Digital Input	Green
3	X2+	X2 Digital Input	Green/White	13	SHIELD	Shield	Shield
4	X2-		Green/Black	14	XCOM	X5-X8 Digital Input COM	Red
5	X3+	X3 Digital Input	Yellow/White	15	Y1	Y1 Digital Output	Brown
6	X3-		Yellow/Black	16	Y2	Y2 Digital Output	Gray
7	X4+	X4 Digital Input	Orange/White	17	Y3	Y3 Digital Output	White
8	X4-		Orange/Black	18	YCOM	Y1-Y3 Digital Output COM	Black
9	X5	X5 Digital Input	Blue	19	Y4+	Y4 Digital Output	Purple/White
10	X6	X6 Digital Input	Purple	20	Y4-		Purple/Black

6.3 Others

Regeneration Clamp

P/N: RC880

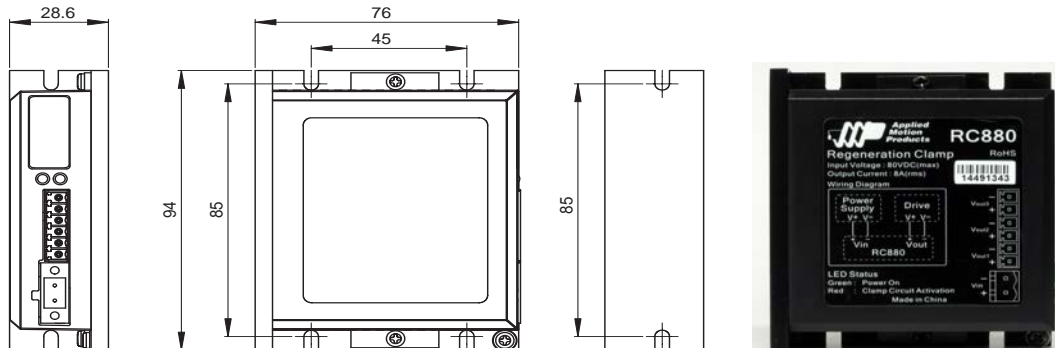

When using a regulated power supply you may encounter a problem with regeneration. The kinetic energy caused by regeneration is transferred back to the power supply. This can trip the overvoltage protection of a switching power supply, causing it to shut down. Applied Motion Products offers the RC880 “regeneration clamp” to solve this problem. If in doubt, use an RC880 for the first installation. If the “regen” LED on the RC880 never flashes, you don’t need the clamp.

USB Serial Adapter

P/N: 8500-003



Power Supplies

P/N	Power	Voltage
PS150A24	150W	24VDC
PS320A48	320W	48VDC
PS480D72	480	72VDC

7 Contacting Applied Motion Products



404 Westridge Dr.
Watsonville, CA 95076, USA
1-800-525-1609
www.applied-motion.com